

# XGMF White Paper

## 5G Enhancement with Millimeter Wave Deployment

Ver. 4.0 January 28th, 2025

*The XG Mobile Communications Promotion Forum*

*ODAIBA IX Core*



#### Notices

- 1 . The copyright of this document is owned by the XG Mobile Communications Promotion Forum (XGMF)
- 2 . No part of this document may be published, translated, or reprinted on any other website in any form or by any means without the prior consent of XGMF.

## Table of contents

Introduction.....	7
1 Clarifying the need for millimeter wave .....	11
1.1 Securing frequency resources for future traffic increases .....	11
1.2 Support for future high-speed, large-capacity, low-latency services .....	15
1.3 Economy, energy efficiency .....	16
1.4 Developing new use cases.....	17
1.5 A foothold for additional frequency allocations in the future.....	17
References .....	18
2 Trends in Japan and overseas .....	19
2.1 Overviews of the trends.....	19
2.1.1 Frequency allocation trend.....	19
2.1.2 Commencement status of millimeter wave commercial services, etc. in each country (overview).....	21
2.1.3 Status of millimeter wave terminals.....	24
2.1.4 3GPP standardization trends.....	25
2.2 Trends in each country (excluding Japan).....	25
2.2.1 USA.....	25
2.2.2 Europe.....	26
2.2.3 China.....	27
2.2.4 South Korea.....	28
2.2.5 India.....	28
2.2.6 Australia.....	29
2.2.7 Southeast Asia .....	29
References .....	30
3 Challenges for widespread use of millimeter wave.....	32
3.1 Millimeter wave introduction area .....	32
3.2 Base station equipment for millimeter wave.....	33
3.3 Millimeter wave terminal.....	34
3.4 Millimeter wave use cases.....	35
3.5 Overall issues.....	35
References .....	36
4. Millimeter wave technology overview .....	37
4.1 Beamforming technology.....	37
4.2 MIMO technology.....	39
4.2.1 LoS-MIMO.....	39

4.2.2	Massive-MIMO/Distributed-MIMO .....	39
4.3	Topology improvement technology .....	41
4.4	Millimeter wave device technology .....	44
4.5	Infrastructure sharing.....	45
4.6	Millimeter wave Carrier Aggregation (CA) .....	46
4.7	sub6 + millimeter wave Dual Connectivity (DC).....	47
4.8	High-Power UE (HPUE) .....	48
4.9	Sub-band full-duplex (SBFD) .....	48
4.10	High-speed train (HST) .....	50
4.11	Use of AI/ML (AI/ML for beam management) .....	52
	References .....	55
5	Performance evaluation .....	57
5.1	5G millimeter wave throughput and latency performance measurement (one-to-one communication in an ideal environment) .....	58
5.2	5G millimeter wave indoor environment measurement .....	61
5.3	5G millimeter wave outdoor environment measurement.....	63
5.4	Performance evaluation of 5G millimeter wave at event venues.....	68
5.5	User experience evaluation of 5G millimeter wave networks.....	70
5.5.1	User experience measurement of SNS in crowded spots .....	70
5.5.2	X (Twitter) Feed Update Time.....	71
5.5.3	X (Twitter) Posting Time for Video Posts.....	72
5.5.4	Promoting the Benefits of 5G Millimeter Wave Networks Based on User Experience .....	72
5.6	Evaluation of Coverage Extension by Millimeter Wave Repeaters .....	73
5.7	5G millimeter wave Challenges and Solutions.....	76
	References .....	78
6	Millimeter wave introduction scenario .....	79
7	Affinity with local 5G.....	82
7.1	What is local 5G?.....	82
7.1.1	Regulation overview .....	82
7.1.2	Allocated frequency bands (sub6, millimeter wave).....	83
7.2	Current state of local 5G .....	84
7.2.1	Overview (past history to popularization) .....	84
7.2.2	Situation for millimeter wave (actual situation) .....	86
7.3	Affinity between millimeter wave and local 5G .....	89
7.3.1	Area scale and radio wave characteristics (good compatibility with	

millimeter wave coverage area) .....	89
7.3.2 Communication capacity and communication demand (good compatibility with high speed and large capacity) .....	90
7.3.3 Compact system scale (good compatibility with system scale and ultra-low latency) .....	92
References .....	95
8 Millimeter wave use case .....	96
8.1 eMBB .....	96
8.1.1 Entertainment.....	96
8.2 FWA.....	100
8.3 Enterprise networks .....	100
8.3.1 Manufacturing industry .....	101
8.3.2 Automobiles.....	102
8.3.3 Medical care .....	102
8.3.4 Media .....	103
8.3.5 Public infrastructure .....	104
8.3.6 Agriculture .....	105
8.3.7 Exhibitions and Other Events.....	105
References .....	107
9 Existing solutions for millimeter wave dissemination.....	109
9.1 Terminal .....	109
9.2 Base station.....	112
9.3 Antenna device.....	113
9.4 Measurement evaluation equipment.....	115
9.4.1 FR2 terminal performance test.....	115
9.4.2 FR2 area test.....	115
9.4.3 Radio wave environment monitor.....	117
9.5 Repeater.....	118
10 Millimeter wave business outlook .....	120
10.1 Area development .....	120
10.2 Promoting and supporting 5G/millimeter wave to other industries.....	121
10.3 Providing a place to promote the spread of millimeter wave .....	123
10.3.1 For consumer users.....	123
10.3.2 Millimeter wave lab for consumer services developers.....	124
10.3.3 Local 5G developer millimeter wave labs .....	124
10.4 5G wireless human resource development.....	124

References .....	124
Conclusion.....	125
Appendix (Existing solutions for the spread of millimeter wave List of reference information links) .....	127
Terminal solution example .....	127
Examples of base station solutions .....	127
Antenna device solution example.....	128
Measuring instrument solution example.....	128
Repeater solution example.....	128

## **Introduction**

In Japan, for the commercialization of 5G, a new frequency band of 3.7 GHz and 4.5 GHz called sub6 was allocated, along with millimeter wave in the 28 GHz band with a wide bandwidth of 400 MHz per operator. In addition, the 28 GHz band is also allocated to local 5G for spot use in limited areas by entities such as local companies and local governments, along with the 4.7 GHz band. Even in the international standardization of 3GPP, standard specifications supporting millimeter wave was included from the initial specifications of 5G. However, the commercial deployment of 5G is currently limited to the 5G refarming of the low- and mid-bands used in 3G and 4G, and the sub6 (in this document, the newly allocated 3.7 GHz and 4.5 GHz bands are defined as sub6 ), and the introduction of millimeter wave has not progressed sufficiently in terms of area and the spread of terminals. For the global situation, several countries have allocated millimeter wave in the 26GHz, 28GHz, and 39GHz bands, but commercial deployment focuses on low-band, mid-band, and sub6, as in Japan, and Countries where millimeter wave commercial deployment has started are extremely limited.

On the other hand, due to its wide frequency bandwidth, millimeter wave is expected to play a major role in the creation of new service fields by realizing ultra-high-speed, large-capacity communication, low-delay communication, etc., which are one of the characteristics of 5G. Traffic volume continues to increase, and expectations are high for future traffic accommodation by millimeter wave.

Considering these expectations, we will contribute to industrial use and the resolution of social issues, promote the spread of millimeter wave as a prerequisite for new 5G/6G frequency allocation, and promote international initiatives related to millimeter wave in Japan. In January 2023, a millimeter wave promotion ad-hoc was established within 5G Mobile Promotion Forum (5GMF) for the purpose of demonstrating these purposes. As one of the major millimeter wave promotion ad-hoc activities, this white paper summarizes the deployment status, challenges, technologies, use cases, solutions, etc. of millimeter wave in Japan and overseas.

On April 1, 2024, 5GMF was integrated with Beyond 5G Promotion Consortium and newly began activities as XG Mobile Promotion Forum (XGMF). Within XGMF, ODAIBA IX (Industry Transformation) Core project was launched as a project to coordinate and succeed the activities of the former 5GMF's Millimeter Wave Promotion Ad Hoc, Application Committee, and Local 5G related activities. This white paper originally created by the 5GMF reflects the activities of XGMF's ODAIBA IX Core project and continues to be updated.

The structure of this white paper and the outline of each chapter are as follows.

1. Clarifying the need for millimeter wave

Telecommunications will play an even more important role in developing society and building a sustainable society in the future, and the utilization of millimeter wave, which is characterized by high speed, large capacity, and low delay, is extremely important. In this chapter, we discuss the necessity of millimeter wave to secure frequency resources for future traffic increases, support for future high-speed, large-capacity, low-delay services, economy, energy efficiency, development of new use cases, and foothold of additional frequencies allocation in the future. We are trying to clarify from the five viewpoints.

2. Domestic and international trends

While 5G services are progressing in countries around the world, the use of millimeter wave remains limited despite progress in frequency allocation. This chapter summarizes the details of frequency allocation, the status of commercialization services, etc., the status of millimeter wave supporting terminals, and 3GPP standardization trends as trends in millimeter wave in Japan and overseas.

3. Challenges for widespread use of millimeter wave

Currently, the 5G area is mainly developed around low band, mid band and sub6, and the traffic capacity ratio of millimeter wave is extremely low. This chapter analyzes the challenges in improving the millimeter wave situation from four perspectives: millimeter wave deployment area, millimeter wave compatible base station equipment, millimeter wave compatible terminals, and millimeter wave use cases.



4. Millimeter wave technology overview

This chapter comprehensively covers technologies that are considered to be effective in resolving the issues of widespread use of millimeter wave as described in Chapter 3, and technologies related to millimeter wave that have already been developed or are being considered in standardization such as 3GPP, are introducing.

5. Performance evaluation

In order to disseminate millimeter wave, it is important to understand their high-speed, large-capacity and low-delay characteristics quantitatively. In this chapter, specific experimental and measurement results using 5G millimeter wave show that millimeter wave can achieve extremely high throughput and delay performance in both indoors and outdoors, and also can be fully utilized in indoors even under non-line-of-sight conditions.

6. Millimeter wave deployment scenario

Since millimeter wave is high frequency band, it is important to make use of their characteristics. Since the cell radius becomes relatively small due to the large propagation loss, it is effective for use cases in narrow and closed areas. High-speed, large-capacity capability due to a large frequency bandwidth is effective in places with heavy traffic and in places where high-speed services are required. Based on these characteristics, this chapter presents several specific millimeter wave deployment scenarios.

7. Affinity with local 5G

With local 5G, it is assumed that many terminals will be used intensively at the same time in a relatively narrow area, so it can be said that millimeter wave that can handle ultra-wideband have a very high affinity with local 5G. While this chapter describes the background and local 5G dissemination status, as well as the limited use of millimeter wave and their challenges, It is explained in terms of communication capacity, communication demand, and system scale.

8. Millimeter wave use case

For the millimeter wave dissemination, it is important to clarify use cases that can take advantage of the high speed, large capacity, and low latency of millimeter wave. In this chapter, we divide applications into three categories: "high-capacity high-speed (eMBB) in facilities such as stadiums where people gather", "FTTH replacement by FWA", and "corporation-dedicated network". Stating the case.

9. Millimeter wave solutions

In order to promote the millimeter wave dissemination, it is important to be able to procure enough devices and measuring instruments for developing and manufacturing the equipment that constitutes the network. This chapter introduces solutions for terminals, base stations, antennas, measuring instruments, etc. based on actual examples.

10. Millimeter wave business outlook

The key to future business outlook for millimeter wave is how to convert this negative chain reaction, in which millimeter wave network deployment, terminal spread, and service development are slow to progress, into a positive chain reaction. This chapter summarizes what can be considered as business and institutional efforts to convert the current situation to a positive chain reaction. Area expansion, 5G/millimeter wave promotion and support activities for other industries, provision of a place to promote millimeter wave spread, and development of 5G wireless human resources are discussed.

As mentioned above, this white paper comprehensively describes the information necessary for the millimeter wave dissemination. It is expected that this white paper will be used to promote the millimeter wave dissemination both in Japan and overseas and to build an ecosystem.

## **1 Clarifying the need for millimeter wave**

By now, there is no doubt that the development of mobile communications from 1G to 5G has played an important role in the development of society. The role of communication will become even more important in building a sustainable society in the future. In order to respond to this, it is extremely important to utilize millimeter wave, which is characterized by high speed, large capacity, and low delay. Furthermore, toward 6G in the 2030s, millimeter wave solutions will serve as a basis for studies, and is a prerequisite for consideration of sub-terahertz band utilization. Several aspects of the millimeter wave need are detailed below.

### **1.1 Securing frequency resources for future traffic increases**

Over the past several decades, mobile communication traffic has continued to increase with the spread of multimedia services and smartphones. Furthermore, with the introduction of 4G, the demand for not only human communication but also physical communication is increasing due to the dissemination of IoT (Internet of Things). In addition, in various industries, there is a growing need for converting wired communication to wireless technology using 5G, and for business efficiency improvement through communication with the progress of DX. Against this background, mobile communication traffic has continued to increase, and as shown in Fig. 1-1, traffic has increased 1.1 times over the past year and 1.6 times (+ 64.6 %) over the past three years. These trends are expected to continue in the future, and there is a possibility that new mobile communication needs will arise in the future, and further increases in mobile communication traffic are expected.

## Current Status of Mobile Communication Traffic (June 2024) 1

- Six mobile network operators (NTT DoCoMo, KDDI (including Okinawa Cellular Phone), SoftBank, Rakuten Mobile, UQ Communications, Wireless City Planning) reports to compile and analyze data on the amount of mobile communication traffic (non-voice)
- The aggregate value of mobile communication traffic in June of Reiwa 6 is
  - Average Monthly Traffic 8,501.4 Gbps (Approximately 1.2 times (+17.4%) in 1 year, 1.6 times (+64.6%) in 3 years)
  - Busy Time Traffic 11661.4 Gbps (Approximately 1.2 times (+16.1%) in 1 year, 1.6 times (+61.8%) in 3 years)
  - Average traffic per contract 38,548.9 bps (Approximately 1.1 times (+13.2%) in 1 year, 1.5 times (+46.4%) in 3 years)

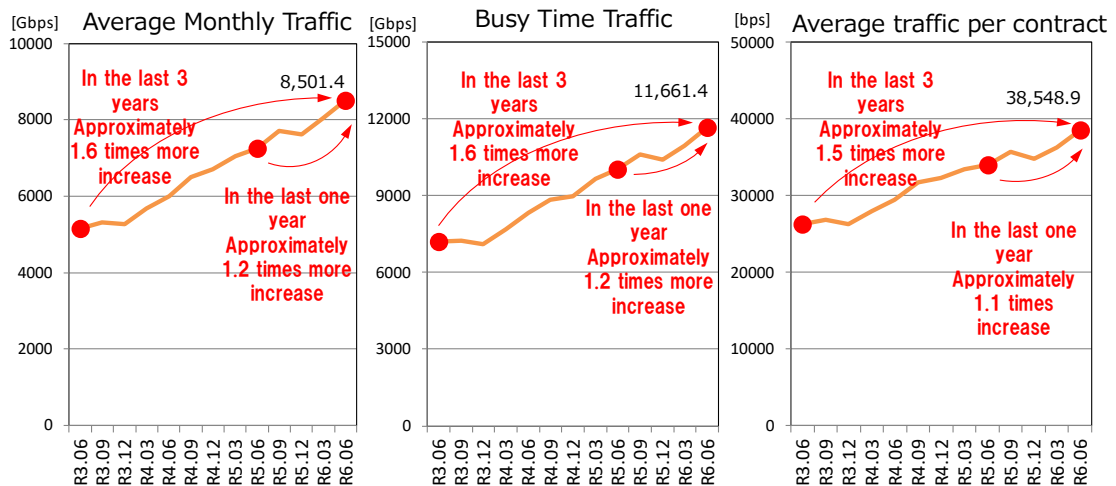

Fig. 1-1 Changes in mobile communication traffic [1]

In response to the increase in traffic due to these factors, it is expected that the current deployment of 5G, mainly sub6, will increase the capacity, and that the technological enhancement of mobile communication systems will increase the communication capacity. It is considered that only these aspects would not be able to cope with traffic increase. According to the GSMA report [2], as shown in Fig. 1-2, millimeter wave frequency resources of 4.5 GHz, 350 MHz, and 150 MHz, respectively, and a total of 5 GHz will be required by 2030 for three types of use cases: eMBB, FWA, and enterprise networks. reported as necessary. For these reasons, utilization of millimeter wave frequency resources is essential.

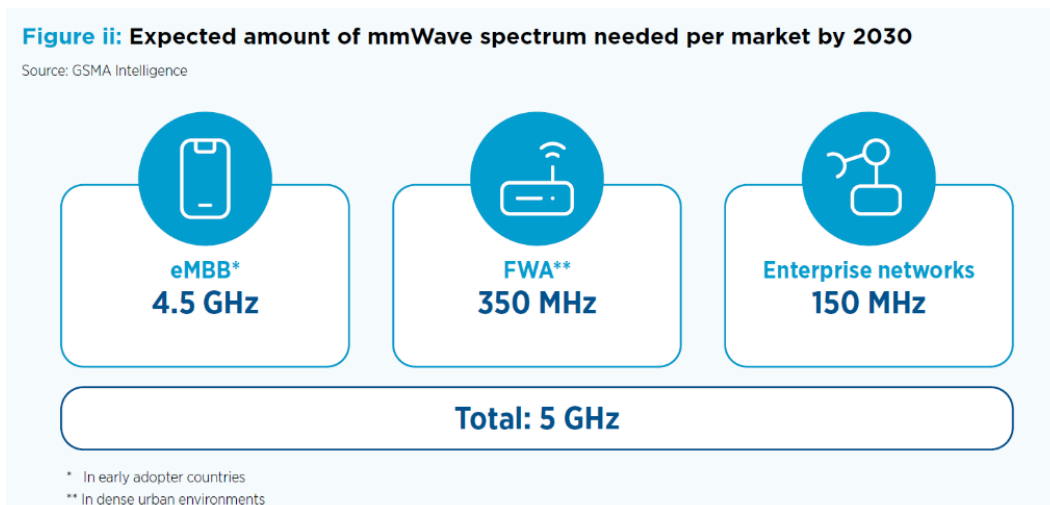

Fig. 1-2 Millimeter wave frequency demand forecast up to 2030[2]

Applications and services utilizing AI, represented by generative AI, are rapidly spreading. However, currently, they mainly focus on text and still images, and there is no significant trend of increased traffic. Nevertheless, it is anticipated that the use and spread of AI targeting videos will lead to a dramatic increase in traffic in the future. Fig. 1-3 shows a comparison of traffic increase and frequency traffic capacity, considering the impact of AI for both uplink and downlink in the United States by Mobile Experts. The frequencies considered in this figure are below 14GHz, and millimeter wave is not considered. As can be seen from the figure, there is a possibility of a significant increase in uplink traffic. Until 2028, it is expected that uplink traffic can be accommodated within the existing and new frequency bands below 14GHz, but after that, it is assumed that these frequency bands alone will not be able to accommodate the demand for uplink traffic. Since millimeter wave is effective for high-speed, large-capacity uplink in high-traffic areas, it is believed that the spread of millimeter wave will address the dramatic future increase in uplink traffic due to AI.

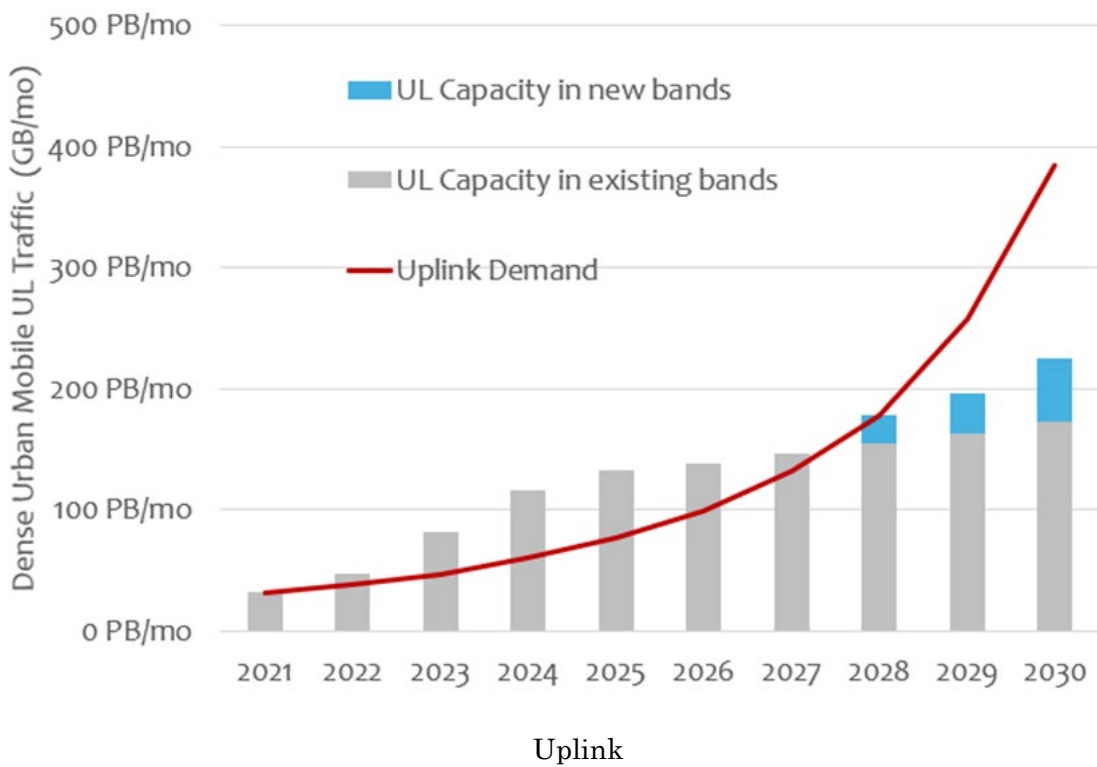
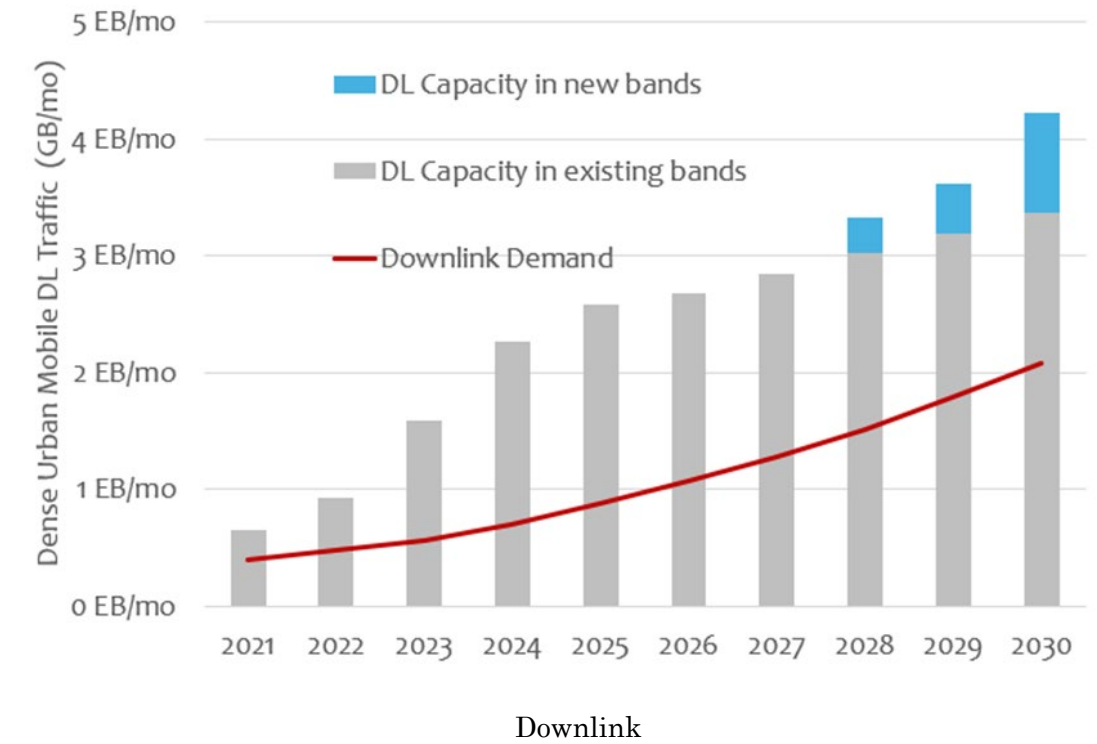

Fig. 1-3 Comparison of traffic increase and frequency traffic capacity in the United States [3]

## **1.2 Support for future high-speed, large-capacity, low-latency services**

Many services and applications have been developed that take advantage of the high-speed, large-capacity and low-latency characteristics of 5G, and further development is expected. For enterprises, there are many needs such as remote monitoring and remote control, security by AI processing of images, watching over, prediction of failures and failures, etc., and more advanced services will be developed. In order to support these, 4K and even 8K video quality will be required in the future, and it is considered that a communication infrastructure which can support such transmission will be required.

Many services and applications utilizing XR devices have already been provided for both consumer and enterprise use. It is thought that new attractive services and applications will be created.

Regarding robotics, it is thought that the introduction of robots not only for special applications in factories, but also in the environment where people live will spread at an accelerated pace in the future, and services such as monitoring, watching over, and nursing care using robots will be disseminated.

There is no doubt that services and applications utilizing AI, represented by generative AI, will be explosively created and spread in the future. Services and solutions that combine video, XR, robotics, and AI will also be developed one after another with synergistic effects.

These are only examples, and it is believed that various advanced services and applications will be developed in the future along with the development of devices and AI. Along with this, the need for high-speed, large-capacity and low-delay communication is expected to increase. Conversely, the provision of high-speed, large-capacity, low-delay services in the right places will promote the development and spread of these advanced services and applications.

### 1.3 Economy, energy efficiency

While a rapid increase in communication traffic is expected, it is considered that intensive traffic will occur in specific places and areas such as stadiums, indoor shopping malls, train stations, and outdoor places with a high density of people. A study [4] shows a case where traffic will increase by 116% from 2021 to 2026 in a specific location, as shown in Fig. 1-4.

On the other hand, as the implementation cost per unit of data traffic for millimeter wave is declining year by year, the implementation cost for millimeter wave will drop by 75% compared to midband by 2026, and the need for small cells per hot zone will increase. In 2025, the number is expected to drop by 74% compared to the mid-band, and the power consumption is expected to be reduced by about 70%. By installing millimeter wave base stations in strategic locations, it is possible to respond to increasing traffic with high economic efficiency, thereby reducing the TCO (Total Cost of Ownership) of telecommunication carriers' 5G communication networks.

In the first analysis, we demonstrated that telecom operators could serve 5G subscribers with better profitability and technically superior solution by investing in 5G mmWave.

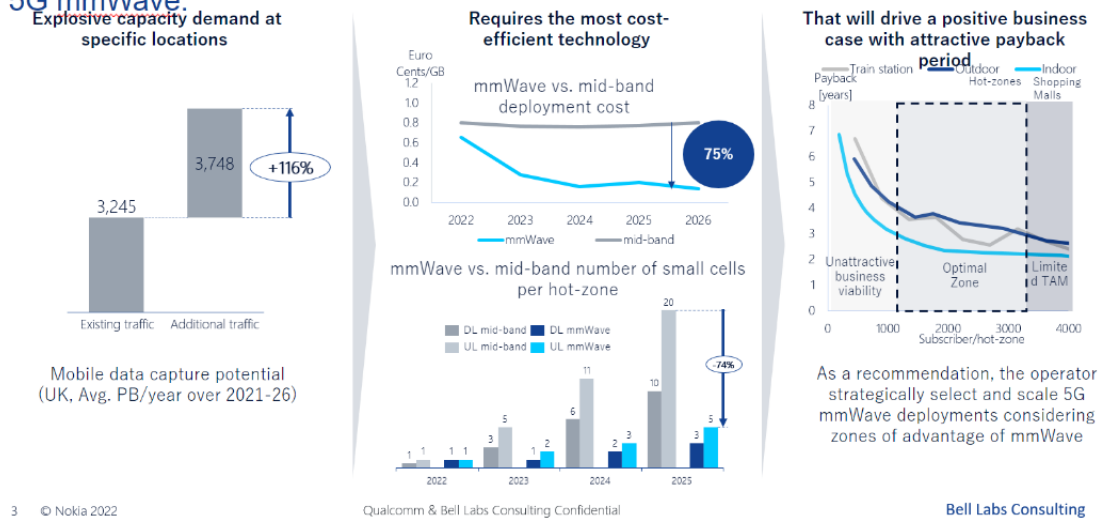

Fig. 1-4 Millimeter wave implementation cost and expected power consumption survey results [4]



#### **1.4 Developing new use cases**

The high directivity and broadband characteristics of millimeter wave, as well as operation by beamforming, have the potential to open up new use cases. For example, in positioning [5-8], where a 5G base station or 5G mobile station transmits and receives a reference signal for positioning and determines the position of the mobile station based on the propagation delay difference and angle of arrival, etc., millimeter wave can be used. It has been reported that centimeter-level positioning accuracy can be achieved [9]. In the future, we will further develop a sensing function that estimates the position, shape, and state of any object, not limited to 5G mobile stations, by measuring reflected radio waves, and joint communication & sensing [10] that fuses 5G data communication and sensing. Standardization is also envisaged. Joint Communication & Sensing is expected to create unprecedented new services such as traffic monitoring by 5G networks [11].

#### **1.5 A foothold for additional frequency allocations in the future**

As mentioned above, the use of millimeter wave is expected for various reasons, but each reason is continuous rather than short-term. Therefore, the currently allocated frequencies including the 28 GHz band will not be sufficient in the future, and additional frequency resource allocation and utilization will be required even in the 2020s. Considering expectations for higher speed, larger capacity, and lower latency in the future, frequency resources with a wide bandwidth to some extent are required, and additional frequency bands of quasi-millimeter wave and above are expected to be utilized. In order to utilize these additional frequencies in a timely manner and to promote social development in the future, it is essential to develop solutions and have operational skills that will allow the 28 GHz band to be fully utilized from the present stage.

Studies on 6G towards 2030s are already underway [12-14], but ultra-high-speed, large-capacity 10 to 100 times faster than 5G, ultra-low latency will be required, and frequencies are sub-bands of several hundred GHz. Even terahertz is being considered. However, when considering the use of sub-terahertz, the use of millimeter wave is a major prerequisite, and on the other hand, unless the technology and skills that allow millimeter wave to be used firmly in 5G are put into practical use at this stage, Terahertz considerations become meaningless. Conversely, by firmly establishing and operating millimeter wave solutions at this stage, it is possible to efficiently develop sub-terawave solutions.

As mentioned above, for the sustainable development of society, it is important to allocate and utilize additional 5G frequencies in the 2020s, and to consider sub-terahertz for 6G. There is an urgent need to develop solutions, develop use cases, and establish operational skills for that purpose.

## References

- [1] Ministry of Internal Affairs and Communications Information and Communications Statistics Database  
<https://www.soumu.go.jp/johotsusintokei/field/data/gt010602.pdf>
- [2] GSMA Vision 2030: mmWave Spectrum Needs, Full Report  
<https://www.gsma.com/spectrum/wp-content/uploads/2022/06/5G-mmWave-Spectrum.pdf>
- [3] Mobile Experts Inc., Uplink Traffic for AI Will Break the 5G Network  
<https://www.prnewswire.com/news-releases/uplink-traffic-for-ai-will-break-the-5g-network-302232446.html>
- [4] Bell Labs Consulting, The business of 5G mmWave, 2022.
- [5] 3GPP TR 38.855, v16.0.0, Study on NR positioning support
- [6] 3GPP RP-190752, New WID: NR Positioning Support, Ericsson
- [7] 3GPP TR 38.857, v17.0.0, Study on NR positioning enhancements
- [8] 3GPP RP-210903, Revised WID on NR Positioning Enhancements, Intel Corporation, CATT
- [9] ‘Experimental Investigation of 5G Positioning Performance Using a mmWave Measurement Setup,’ 2021 International Conference on Indoor Positioning and Indoor Navigation (IPIN), George Yammine, et al.
- [10] ‘Multibeam Design for Joint Communication and Sensing in 5G New Radio Networks,’ 2020 IEEE International Conference on Communications (ICC), Carlos Baquero Barneto, et al.
- [11] <https://www.ericsson.com/en/blog/2021/10/joint-sensing-and-communication-6g>
- [12] Ministry of Internal Affairs and Communications Promotion Strategy –Beyond 5G Promotion Strategy Roadmap to 6G–  
[https://www.soumu.go.jp/main\\_content/000696613.pdf](https://www.soumu.go.jp/main_content/000696613.pdf)
- [13] [12] Ministry of Internal Affairs and Communications, “Beyond 5G Promotion Strategy (Overview), June 2020.  
[https://www.soumu.go.jp/main\\_content/000702111.pdf](https://www.soumu.go.jp/main_content/000702111.pdf)
- [14] Beyond 5G Promotion Consortium White Paper <https://b5g.jp/output/>

## **2 Trends in Japan and overseas**

There are great expectations for 5G services as a new social infrastructure that will bring significant economic benefits, and services are progressing in countries around the world. Despite the fact that millimeter wave is necessary to make full use of the true potential of 5G, its use is limited in all countries except the United States.

Under these circumstances, Japan is the second most commercialized country after the United States, and the government and industry are discussing how to take the initiative in the world in the future.

This chapter provides an overview of the trends in Japan and overseas regarding millimeter wave.

### **2.1 Overviews of the trends**

#### **2.1.1 Frequency allocation trend**

In countries around the world, 400MHz to 1000MHz bandwidth is mainly allocated in the 26/28GHz band for 5G service applications. Millimeter wave frequencies are available in 31 countries by December 2022, and frequencies are allocated for commercial deployment in 18 countries in 2022, and 28 operators (including private network operators) have started commercialization (Fig. 2-1). In ten countries including Japan, millimeter wave is allocated not only for public networks but also for private networks (Fig. 2-2). In addition, it is expected that the number of countries and regions where the use of millimeter wave becomes possible will gradually increase, such as the implementation of frequency auctions in each country.

WTP (Willingness To Pay) and ARPU (Average Revenue Per User) tend to improve as millimeter wave use progresses in each country. It has been reported that millimeter wave has not yet become mainstream in the evolution of 5G services [3]. Only 20% of the carriers that have been allocated millimeter wave have commercialized them, the share of terminals that support millimeter wave is 10%, and flagship terminals in each country doesn't support millimeter wave.

In Japan, in April 2019, sub6 (3.6 GHz to 4.1 GHz, 4.5 GHz to 4.6 GHz) and millimeter wave (27.0 GHz to 28.2 GHz, 29.1 GHz to 29.5 GHz) were assigned to four mobile network operators as frequencies for 5G. Also, in December 2019, local 5G was regulated for some frequencies (28.2 GHz to 28.3 GHz, 100 MHz width), and acceptance of license applications started at the end of Japanese FY2019. In December 2020, the frequency for local 5G was extended (4.6 GHz to 4.9 GHz, 28.3 GHz to 29.1 GHz).

Regarding local 5G, its utilization has not progressed as much as had been expected though millimeter wave was allocated earlier than sub6. It was assumed that it would be operated by the NSA with LTE carriers as anchors, and also mobile operators have not used millimeter wave at that occasion.

Currently, the Japanese government is considering additional allocations for the 4.9 GHz band (4.9 GHz to 5.0 GHz) / 26 GHz band (26.6 GHz to 27.0 GHz) / 40 GHz band (39.5 GHz to 43.5 GHz) [4].

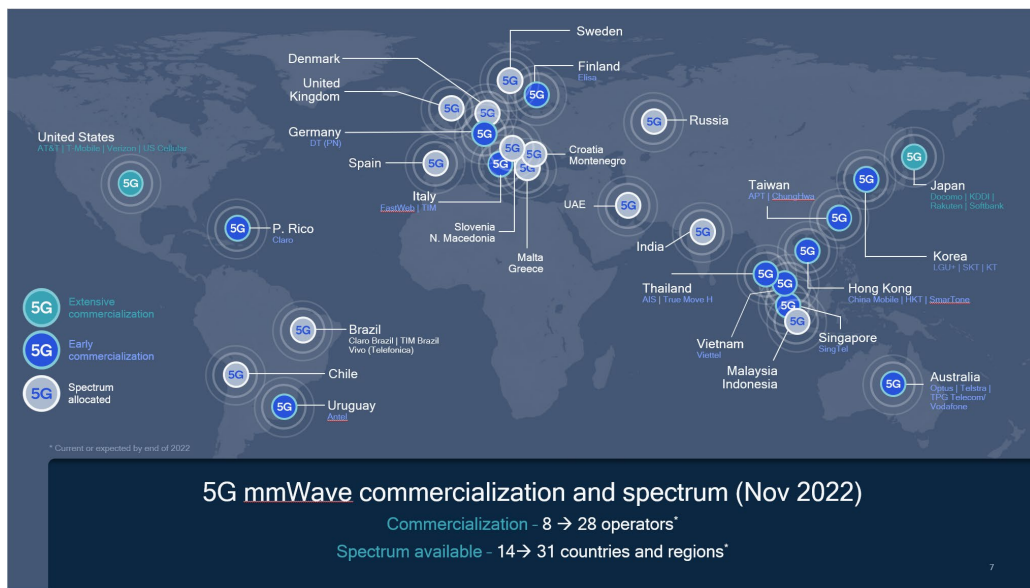

Fig. 2-1 5G millimeter wave commercialization and spectrum (as of November 2022)

[1]

## mmWave spectrum

June 2024 status

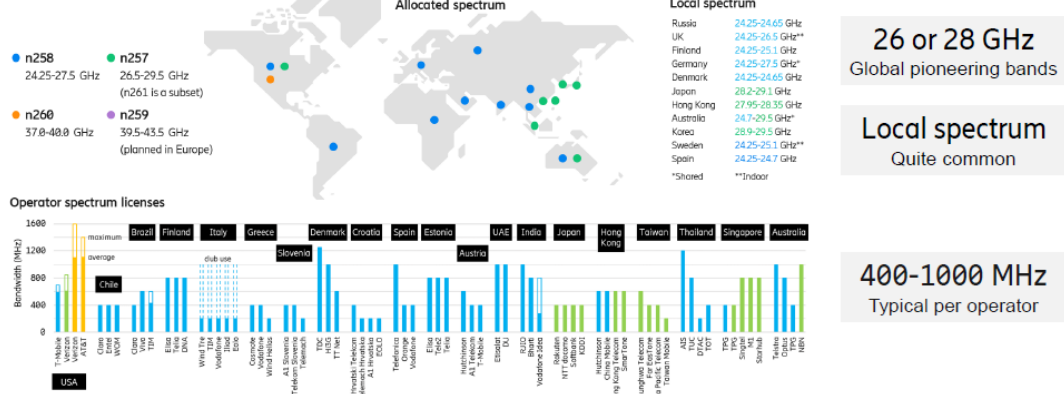

Fig. 2-2 Global millimeter wave spectrum (as of June 2024) [2]

## 2.1.2 Commencement status of millimeter wave commercial services, etc. in each country (overview)

### (1) Overall

As of November 2022, full commercial services using millimeter wave are limited to the United States and Japan. Early stages of commercialization include European countries/region such as Germany, Italy, Finland and Spain, and Asian such as Australia, Taiwan, Hong Kong and Singapore.

As mentioned in Chapter 1, millimeter wave can efficiently build networks by taking advantage of their economic efficiency. It is expected that it will be possible to return the investment efficiently [5].

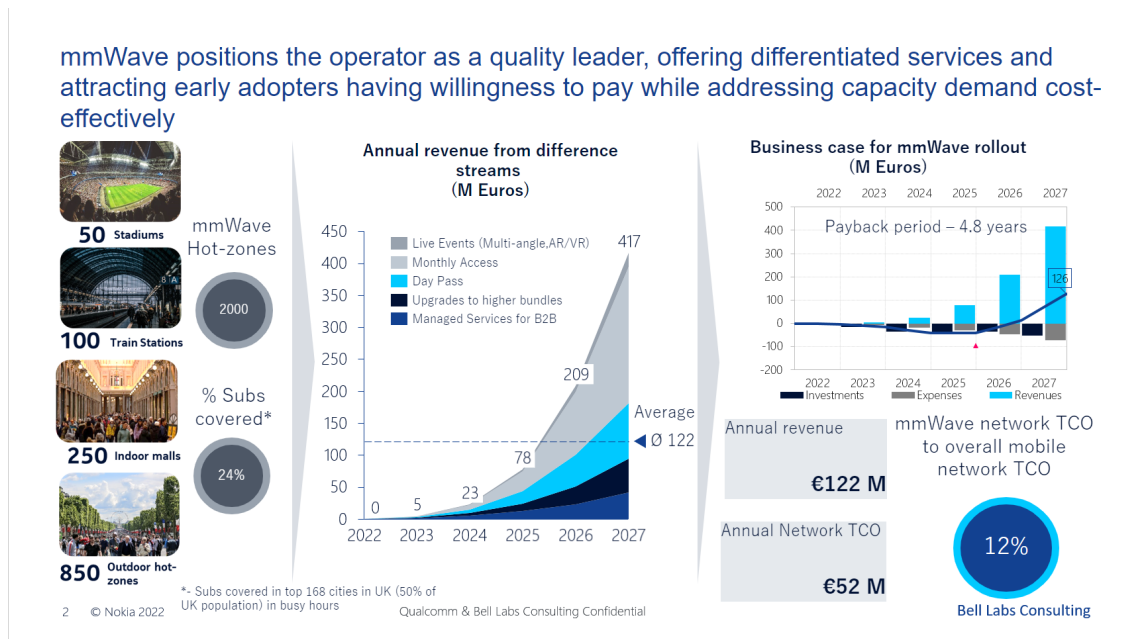

Fig. 2-3 Examples of economic effects of millimeter wave [5]

## (2) Japan

In Japan, millimeter wave was assigned to four operators in 2019, and commercial services have started.

According to the Ministry of Internal Affairs and Communications (MIC), the domestic population coverage rate of 5G has reached 96.6% as of the end of March 2023[6]. But the number of 5G base stations is mostly occupied by those base stations of refarming 4G frequencies such as 700MHz, 1.7GHz and 3.4GHz/3.5GHz. Total number of these base stations is 86,513 stations (up to 93.8% population coverage). On the other hand, the total number of sub6 (3.7GHz, 4.0GHz/4.5GHz) base stations is 59,950 (maximum population coverage is 42.5%), and the total number of 28GHz base stations is 23,363 stations(maximum population coverage is 0.2%). The contribution to the population coverage rate is 20% to 40% for 3.7GHz and 4.0/4.5GHz, and at a level that does not result in effective numbers as a percentage for all companies in the millimeter wave band. Regarding 5G traffic volume, sub6 covers 52.0%. It has decreased by 10% compared to the end of March 2022. This is because the traffic capacity in the low-band and mid-band has increased by 10%. On the other hand, millimeter wave covers only 0.1% [7]. In 2024, the government announced a set of policies regarding infrastructure, devices, user experience, and frequency allocation to expand 5G business utilizing high-frequency bands such as millimeter wave. First, to further enhance the 5G infrastructure, the Ministry of Internal Affairs and Communications' 'Infrastructure Development Promotion Working Group for 5G Dissemination' has set new infrastructure development goals. For the sub-6GHz band, the goal is to achieve 80% coverage by 2027 as a common target for all companies, and ultimately aim for almost complete coverage. For millimeter wave, the goal is to set the number of base stations (including land mobile relay stations) to 50,000 (total for four operators) by 2027. [8]

Regarding regulations on terminal sales, the Ministry of Internal Affairs and Communications' 'Working Group on Verification of Competition Rules' has stated that to break the 'chicken and egg' situation and form a millimeter wave ecosystem, it is important to promote the spread of millimeter wave terminals along with infrastructure development and the creation of use cases. Therefore, it is appropriate to relax the upper limit on terminal discounts for millimeter wave-compatible terminals. It has been decided that the upper limit on discounts for millimeter wave terminals should be relaxed by 15,000 yen. As a result, the previous upper limit of 40,000 yen (excluding tax) will be relaxed to 55,000 yen (excluding tax). The new system is expected to be introduced around the end of 2024. [9]

Furthermore, the Regulatory Reform Implementation Plan states that the Ministry of Internal Affairs and Communications will take necessary measures to ensure that smartphone users can correctly recognize the frequency bands they are using, as both 5G using frequency bands initially allocated for 4G and 5G using frequency bands allocated for 5G are currently displayed as '5G' on smartphone screens without distinction. As a result, a new display method is expected to be introduced to correctly recognize when sub-6GHz or millimeter wave is being received.[10]

Additionally, the Ministry of Internal Affairs and Communications' 'Frequency Reorganization Action Plan (FY2024 Draft)' states that conditional auctions for the 2 GHz and 40 GHz bands will be conducted by the end of FY2025, aiming to allocate them for 5G. The technical conditions will be compiled around spring 2025, and the technical standards will be formulated around autumn 2025, reflecting the migration measures of existing systems and the status of frequency sharing considerations as appropriate. As a result, not only the existing 28GHz band but also the 26GHz and 40GHz bands are expected to be newly allocated for 5G services. [11]

### Status of 5G Base Stations by Band

- As for the development status of 5G base stations by operator, NTT DoCoMo and Rakuten Mobile are mainly Sub6 and millimeter wave, while KDDI and SoftBank are increasing the number of low-band and mid-band base stations
- The national population coverage rate of 5G (96.6% as of the end of March 2023) is largely due to low-band and mid-band. Sub6 has limited coverage, but it handles the most traffic. As for the millimeter wave band, the number of stations is small, the coverage rate is less than 1%, and the amount of traffic processed is almost nonexistent, so its use is limited.

Number of 5G base stations and population coverage rate by band

	Number of 5G base stations (population coverage)			
	NTT DOCOMO	KDDI	SoftBank	Rakuten Mobile
700MHz	2,930 (29.7%)	12,149 (88.1%)	14,742 (93.8%)	-
1.7GHz	-	5,383 (47.3%)	13,883 (89.4%)	-
3.4GHz/3.5GHz	1,413 (8.7%) / 293 (1.4%)	9,673 (50.9%)	26,047 (77.7%)	-
3.7GHz	10,356 (20.3%)	18,359 (22.6%)	6,458 (31.8%)	11,053 (30.5%)
4.0GHz/4.5GHz	11,513 (42.5%)	2,211 (0.3%)	-	-
28GHz	4,394 (0.0%)	4,193 (0.2%)	4,236 (0.0%)	10,540 (0.0%)

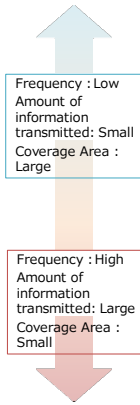

Source: Ministry of Internal Affairs and Communications:

Status of 5G base station development by operator

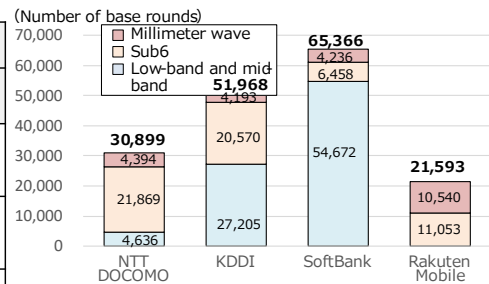

5G traffic volume by band (%)

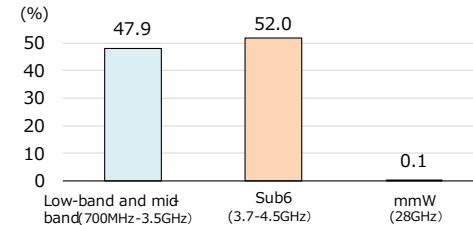

Fig. 2-4 5G Base Station Development by band [7]

### 2.1.3 Status of millimeter wave terminals

#### (1) Global

As of December 2022, more than 170 models of millimeter wave terminals have been announced and released by more than 65 vendors around the world. In addition to smartphones, various products such as PCs, hotspots and IoT devices, modules, and CPEs are being developed[1]. At this moment, the number of countries and models that have been released is limited, but it is gradually increasing. In addition, millimeter wave terminals account for 57.3% of newly shipped terminals in the United States, and are steadily increasing.



Fig. 2-5 Deployment status of millimeter wave terminals [1]

#### (2) Japan

The number of millimeter wave terminals is steadily increasing, with 17 models, mainly high-end models, to be released in Japan in 2022. In the summer 2024 models, only two devices from two manufacturers were introduced. It indicates a trend towards limited support for millimeter wave terminals. While the number of units sold will be just over 1.7 million in 2022, or about 5.2% of the total terminal sales market[1], it is currently declining further. Its share of the handset sales market is much lower than the US. It seems that the reason comes from the fact that 1) unlike the United State, terminals with a high market share do not support millimeter wave and 2) millimeter wave is only supported by high-end terminals. In the future, it will be a challenge not only to support millimeter wave for terminals with a high market share and terminals in a wide price range other than high-end terminals, but also continuously introducing compatible devices into the market.



### 2.1.4 3GPP standardization trends

3GPP has standardized bands n257, n258, n259, n260, n261, n262 as FR2 bands (24250 MHz – 52600 MHz) since Rel-15. In Rel-17, it was extended to the FR2-2 band (52600 MHz – 71000 MHz) and the band n263 was also standardized.

Table. 2-1 millimeter wave bands in 3GPP Release 17

NR Band	Frequency	Duplex	Major regions
n257	26500 MHz – 29500 MHz	TDD	Japan, Korea
n258	24250 MHz – 27500 MHz	TDD	Europe, India, Australia, etc.
n259	39500 MHz – 43500 MHz	TDD	
n260	37000 MHz – 40000 MHz	TDD	USA
n261	27500 MHz – 28350 MHz	TDD	USA
n262	47200 MHz – 48200 MHz	TDD	USA
n263	57000 MHz – 71000 MHz	TDD	

In addition to mobile terminals such as smartphones, specifications for FWA, in-vehicle, and high-speed train terminals have been standardized as applications for millimeter wave. The expansion of the maximum continuous bandwidth (from 1.2 GHz to 2.4 GHz) through carrier aggregation and the addition of specifications for carrier aggregation between millimeter wave bands have been developed by Rel-17. 3GPP standards are continuously being revised in order to further enhance massive-MIMO as introduced in Chapter 4 and improve the performance of millimeter wave communication.

## 2.2 Trends in each country (excluding Japan)

### 2.2.1 USA

In the US, frequencies are assigned to carriers such as AT&T, T-Mobile, and Verizon, and FWA, hotspot in urban areas and high-traffic areas usage have been expanding. In addition, when licensing, it is required to achieve at least 40% population coverage in the area where the license is granted[1].

On the other hand, Verizon is actively using more than 40,000 millimeter wave base stations in more than 1,500 cities across the United States, such as by installing them in bases such as stadiums and stations, as well as in urban areas. It also aims to provide FWA services (millimeter wave and C-band) to 50 million houses by 2025[1].

As for millimeter wave terminals, as shown in Table. 2-2, the increment is progressing smoothly. One of the reasons for this is considered that some models of terminals that have a high market share in the United States have supported millimeter wave since 2020.

Table. 2-2 Spread of millimeter wave compatible terminals in the United States  
(calculated based on IDC)

Year	2019	2020	2021	2022
Market share of millimeter wave terminals	0.3%	4.3%	43.1%	57.3%

Along with the mature deployment of infrastructure and the spread of millimeter wave terminals, the use of millimeter wave has progressed in transportation hubs such as stadiums, stations, indoor shopping malls, and outdoor crowded places. New use cases such as watching a game are emerging. It is reported that various viewing methods using millimeter wave for large-scale sporting events such as American football, Formula 1, and ice hockey are getting to be popular [3]. In this way, B2B2C business using advanced networks that actively use millimeter wave is gradually expanding [3].

### 2.2.2 Europe

Deutsche Telekom (Germany), Elisa (Finland), FastWeb (Italy) and TIM (Italy) are in the early stages of commercialization of millimeter wave. They focus on FWA, smartphones and industrial applications. A project to build multiple model cities is also under consideration and underway [1].

In the UK, millimeter wave of 26GHz (24.25GHz-27.5GHz) and 40GHz (40.5GHz-43.5GHz) will be allocated to mobile technologies such as 5G, then started public consultation on the auction (Q2 2024) design and local licensing conditions in March 2023. Local licenses will be granted on a first-come, first-served basis using a Shared Access licensing framework in key towns and cities (high-density areas) where the greatest number of millimeter wave deployments is expected. Frequency assignment for the entire city/town will be held by auction. Also, in low-density areas, where deployment is expected to be sparse, a shared access licensing framework will be used to grant millimeter wave local licenses on a first-come, first-served basis [12].

In France, in 2023, as part of the France 2030 policy, the government plans to start a new call for proposals (assuming investment of more than 750 billion euros by 2025) and provide support projects [1].

- R&D to accelerate the evolution of 5G and the development of 6G/next-generation networks
- Developing solutions for communication networks that guarantee a high level of security and reliability
- Improving the environmental impact of communication networks

In addition, in France, as part of the European 5G-TOURS research project, efforts in the healthcare field at Rennes University Hospital using the 26 GHz band are progressing [1].

In Spain, at the MWC venue held in Barcelona at the end of February 2023, Telefonica's first millimeter wave commercial base station (manufactured by Ericson) was installed and used for visitors and millimeter wave related exhibitions. At the Qualcomm booth, millimeter wave terminals were exhibited and a speed test demonstration (using Telefonica's millimeter wave base station) was held. In this demonstration, although the results are affected by the communication environment, it was shown that the speed, etc. did not drop significantly even when there was an obstacle such as a PC behind the terminals.

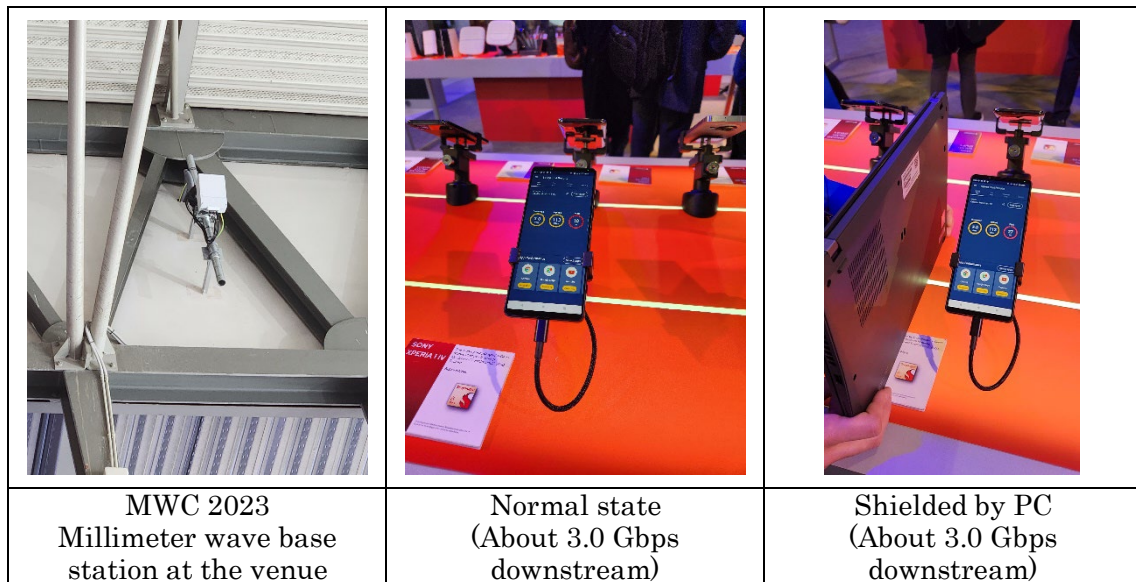

Fig. 2-6 Millimeter wave related technology exhibition at MWC2023

### 2.2.3 China

In China, 5G network deployment using sub6 is progressing rapidly, and 2.3 million base stations have been deployed by December 2022. On the other hand, as of February 2023, no license for millimeter wave has been granted to operators. As a private network license, in October 2022, the first domestic commercial license (5925MHz-6125MHz, 24.75GHz-25.15 GHz frequency) was granted to COMAC (a Chinese aircraft manufacturer) [13].

Millimeter wave is expected to supplement the coverage of 5G services and increase network capacity, and research and development and testing have been carried out so far.

In 2019, China standardized specifications through testing of major technologies, and they put efforts by, completing developments of a test environment for facility testing and performance test system in 2020, SA service testing in 2021, and millimeter wave testing in 2022 [14].

#### **2.2.4 South Korea**

In June 2018, Korea Telecom, SK Telecom, and LG Uplus allotted 800MHz frequencies in the 28GHz band as a result of a frequency auction. An obligation to install 15,000 base stations within three years was imposed.

Although the government continued to encourage investment in the 28Ghz band, each operator prioritized investment in the 3.5GHz band. LGU+ and KT were suspended assignment in November 2022 [16] and SKT in May 2023 [17] before the original quota deadline, November 2023. However, subway services currently in use of millimeter wave will remain available until the original quota deadline [15].

On January 31, 2023, the South Korean government presented a bill to support the entry of new businesses, consisting of lowering the threshold for market entry, initial network construction support, and service operation support. It was expected that the frequency allocation would be announced in the second quarter of 2023, and the selection of new operators would be made in the fourth quarter[15]. In February 2024, Stage X acquired 26.5-27.3 GHz along with the anchor band 700 MHz FDD band as a result of an auction. However, the allocation was withdrawn on July 31.

On the other hand, the construction of the government network with 5G and the development of high-speed networks are being supported by the \$300 million Giga-Korea high-speed project [1].

#### **2.2.5 India**

In India, a frequency auction was held in July 2022, with 1GHz width (SA) for RJIO throughout India, 800MHz width (NSA) for Airtel throughout India, and 400MHz width (SA/NSA (TBD)) for BSNL. Across India, millimeter wave on n258 was assigned with 200-800 MHz band (NSA) to Vodafone being the main market and 400 MHz to Adani Data Network (5G private network operator) in the main market.

In 2023, most operators conducted field demonstrations of FWA and mobility use cases. In 2024, commercial service is expected to begin. The government has imposed an obligation to develop coverage for the next three to five years. [1].

### **2.2.6 Australia**

Five companies won the spectrum in the Australian Communications and Media Authority (ACMA) auction of the 26 GHz band. Telstra Corporation Limited 1GHz band for most regions, Optus Mobile Pty Ltd 800 MHz band for most regions, Mobile JV Pty Limited (JV of Vodafone Hutchison Australia and TPG Telecom) 600 MHz band for most regions, Dense Air Australia Pty Ltd (neutral host operator of the 5G testbed) won 200MHz in a limited area and Pentanet Limited (local ISP in Perth City) won 400MHz in two areas.

The license won at auction has already been effective and valid until 2036[1].

In Australia, the \$28.6 million 5G Innovation Initiative program is funding use case development and demonstration of the value created by 5G[1]. Commercial networks using millimeter wave are being built, and commercial services are already being rolled out in major cities such as Sydney and Melbourne. It has also been introduced in large stadiums where users are concentrated.

### **2.2.7 Southeast Asia**

In Southeast Asia, Singtel (Singapore), CHT and APT (Taiwan. APT is a millimeter wave private NW operator) in 2020, TRUE and AIS (Thailand), CMHK and HKT (Hong Kong), Viettel (Vietnam), in 2021 8 companies in 5 countries/regions have started millimeter wave business.

In addition, including these 8 operators, 16 operators in 5 countries/regions have acquired millimeter wave frequencies.

Singapore has a \$22.5 million grant program to develop new 5G solutions and \$50 million in support for the development of cutting-edge communication technologies.

In Taiwan, Advanced Semiconductor Engineering (ASE) is planning to launch a smart factory business using 5G millimeter wave NR-DC SA [1].

## References

- [1] [https://www.soumu.go.jp/main\\_content/000860192.pdf](https://www.soumu.go.jp/main_content/000860192.pdf) Qualcomm Japan, 5G Business Design WG 2nd meeting Qualcomm materials. (Japanese only)
- [2] [https://www.soumu.go.jp/main\\_content/000860162.pdf](https://www.soumu.go.jp/main_content/000860162.pdf) Ericsson Japan, 5G Business Design WG 2nd meeting Ericsson materials. (Japanese only)
- [3] GSMA, 5G mmWave Circa 2023- State of the Market and Look back at our Accomplishments (MWC2023 GSMA Document).
- [4] [https://www.soumu.go.jp/main\\_content/000857639.pdf](https://www.soumu.go.jp/main_content/000857639.pdf) Ministry of Internal Affairs and Communications, “5G Business Design Working Group” Management Policy. (Japanese only)
- [5] Bell Labs Consulting, The business of 5G mmWave.
- [6] [https://www.soumu.go.jp/menu\\_news/s-news/01kiban14\\_02000561.html](https://www.soumu.go.jp/menu_news/s-news/01kiban14_02000561.html) Ministry of Internal Affairs and Communications, announcement of 5G development status (end of 2021) (Japanese only)
- [7] [https://www.soumu.go.jp/main\\_content/000860636.pdf](https://www.soumu.go.jp/main_content/000860636.pdf) Ministry of Internal Affairs and Communications, 5G Business Design Working Group (3rd) handout. (Japanese only)
- [8] Ministry of Internal Affairs and Communications, Report of the Infrastructure Development Promotion Working Group for 5G Dissemination  
[https://www.soumu.go.jp/menu\\_news/s-news/01kiban14\\_02000650.html](https://www.soumu.go.jp/menu_news/s-news/01kiban14_02000650.html)
- [9] Ministry of Internal Affairs and Communications, Report on the Verification of Competition Rules 2024  
[https://www.soumu.go.jp/menu\\_news/s-news/01kiban03\\_02000951.html](https://www.soumu.go.jp/menu_news/s-news/01kiban03_02000951.html)
- [10] Cabinet Office, Regulatory Reform Implementation Plan (Cabinet Decision on June 21, 2024)  
[https://www8.cao.go.jp/kisei-kaikaku/kisei/publication/program/240621/01\\_program.pdf](https://www8.cao.go.jp/kisei-kaikaku/kisei/publication/program/240621/01_program.pdf)
- [11] Ministry of Internal Affairs and Communications, Frequency Reorganization Action Plan (FY2024 Draft)  
[https://www.soumu.go.jp/menu\\_news/s-news/01kiban09\\_02000526.html](https://www.soumu.go.jp/menu_news/s-news/01kiban09_02000526.html)
- [12] Ofcom, Enabling mmWave spectrum for new uses.
- [13] European 5G Observatory, “The Ministry of Industry and Information Technology (MIIT) has granted the license to a domestic aero plane manufacturer.  
<https://5gobservatory.eu/china-grants-first-5g-private-network-licence/>
- [14] China Academy of Information and Communications Technology (CAICT), Setting Sail on a New Journey with 5G Commercialization (MWC2023CAICTDocument) .

- [15] [https://www.soumu.go.jp/main\\_content/000860119.pdf](https://www.soumu.go.jp/main_content/000860119.pdf) Samsung Networks, 5G Business Design WG 2nd meeting Samsung materials. (Japanese only)
- [16] <https://www.msit.go.kr/bbs/view.do?bbsSeqNo=94&nttSeqNo=3182564> Ministry of Science and ICT, Korea
- [17] <https://www.msit.go.kr/bbs/view.do?bbsSeqNo=94&nttSeqNo=3183048> Ministry of Science and ICT, Korea

### 3 Challenges for widespread use of millimeter wave.

While millimeter wave can be expected to have higher speeds and larger capacities than sub6 due to their wider bandwidth, currently the 5G area is mainly developed around low band, mid band, and sub6, and the traffic accommodation ratio of millimeter wave is extremely low. Issues in improving this situation are analyzed from the perspectives of millimeter wave introduction areas, millimeter wave supporting base station equipment, millimeter wave supporting terminals, and millimeter wave use cases are described below. Many technologies and solutions have already been researched, developed, and introduced to address these issues. For more information, please refer to Chapter 4, Overview of Millimeter Wave Technology, and Chapter 9, Solutions for the Popularization of Millimeter Wave.

#### 3.1 Millimeter wave introduction area

The free space loss for radio wave propagation is given by Equation 1. This means that the radio wave propagation loss increases with the power of 2 of the frequency increment.

Propagation loss  $L=(4\pi d f/c)^2$  d: distance, f: frequency, c: speed of light (Formula 1)

In addition to free space loss, there is also absorption due to molecular vibration in the air, which varies with frequency, resulting in the loss shown in Fig. 3-1.

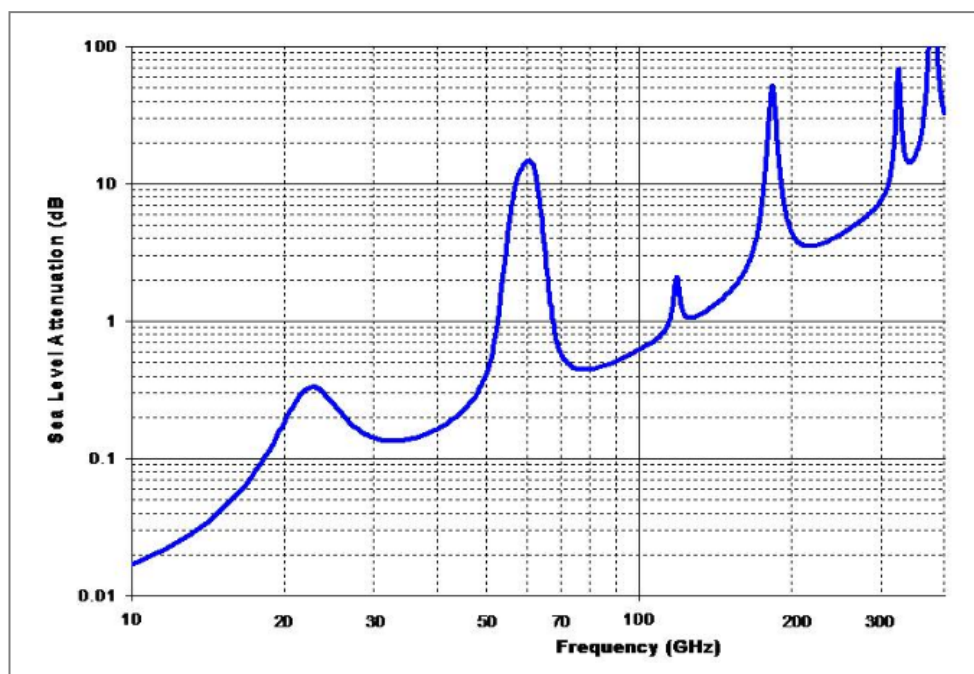

Fig. 3-1 Atmospheric and molecular absorption



In addition, the higher the frequency, the steeper the loss due to shielding, and the reception level greatly decreases in non-line-of-sight (Fig. 3-2).

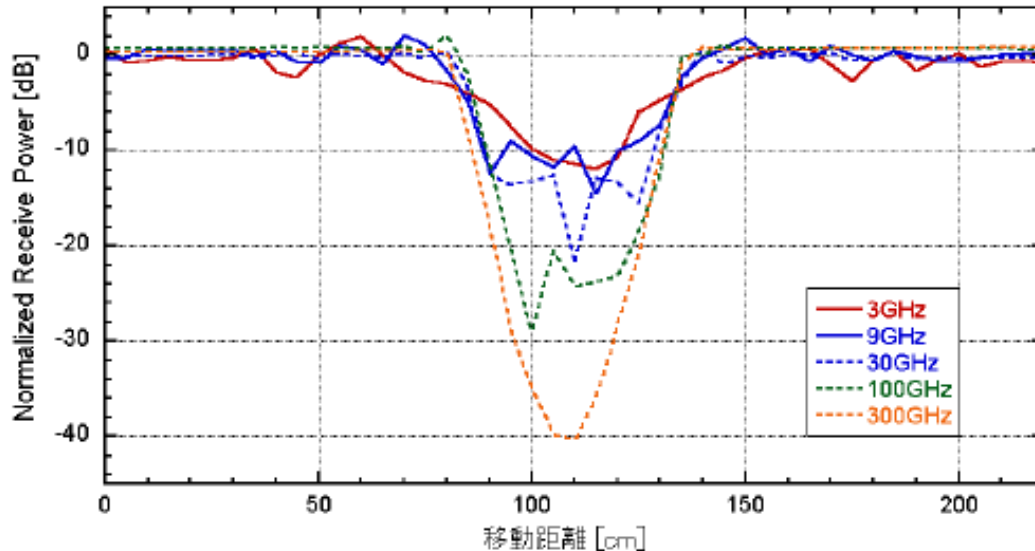

Fig. 3-2 Example of shielding loss measurement results [1]

Due to these radio wave propagation characteristics, the millimeter wave cell radius is smaller than sub6 when compared at the same effective isotropic radiation power. In addition, since the shielding loss is steep and large, it is necessary to install the antenna in a place where the line-of-sight environment can be secured as much as possible. These are issues for mobile network operators in terms of cost and securing antenna installation locations, so currently they are mainly introduced from sub6, which is easy to operate. In order to improve the area of millimeter wave, it is necessary to improve the performance of antennas based on radio wave propagation characteristics, reduce the size of antennas, and develop new solutions to relax restrictions on antenna installation locations.

### 3.2 Base station equipment for millimeter wave

Millimeter wave is a frequency band that will be newly used for mobile communications in 5G, and new development is necessary. The degree of penetration is limited compared to sub6, and the economic effect of the scale of wireless devices is currently low.

As for the base station antenna, it is easier to implement a small antenna compared to sub6, and in order to dramatically improve the antenna gain to cope with the increase in propagation loss, it is mainstream to use a super multi-element antenna.

In addition, since the loss in the device also increases, implementation using an analog RFIC that integrates an antenna and an amplifier to minimize loss is usually used. In this way, millimeter wave base stations have many new points in terms of implementation, and are expected to evolve in the future. For example, the efficiency of a base station amplifier is about several tens of percent for sub6, while that for millimeter wave is as low as tens of percent. Currently, the efficiency of the entire system is improved by using a super-multi-element antenna implementation, and the efficiency of the amplifier itself will also improve in the future. As for the number of MIMO layers, two layers are the mainstream for millimeter wave due to restrictions on equipment size. Also, with respect to the beamforming function by a massive multi-element antenna, full-digital high performance has not yet reached commercial implementation from the standpoint of equipment size, hence hybrid implementation of analog and digital is the mainstream. The development of these functions is being considered as a possibility of future enhancement.

### **3.3 Millimeter wave terminal**

As stated in the entire white paper, millimeter wave use cases are not yet sufficient, and in addition, there are currently not enough areas where millimeter wave can be used. Terminals equipped with millimeter wave are increasing, but the current situation is that they are still limited to high-end terminals. The cost increase associated with supporting millimeter wave, such as the development of millimeter wave antennas, modules, basebands, related SW, etc. mentioned above, leads to a rise in terminal prices, making it difficult to spread to low-end terminals. The current problem is that we have not been able to find benefits that match this price increase, and end users have not been able to enjoy it. In addition, the introduction of millimeter wave will increase the number of parts, which may limit the design of terminals. In the future, the lower cost of introducing millimeter wave, the miniaturization of antenna modules, etc., and the wider coverage of antenna characteristics will be the keys to the spread of terminals.

In addition, the power efficiency of semiconductor devices such as amplifiers for millimeter wave is still lower than that for microwave, and this is one of the main reasons for high power consumption. This also affects battery consumption and heat generation. It is an issue that greatly affects end-user usability. Resolving these issues is also the key to the spread of millimeter wave terminals.

### 3.4 Millimeter wave use cases

Use cases unique to 5G are expanding, such as the need for higher quality video services and remote monitoring and control. However, most of the current use cases are still at a satisfactory level even with the performance of sub6, and the high-speed and large-capacity performance of millimeter wave are not required, which has not led to the spread of millimeter wave. In the future, it will be necessary to appeal and demonstrate the effectiveness of millimeter wave to other industries in order to further improve the quality of use cases and to create new use cases that require millimeter wave.

### 3.5 Overall issues

So far, we have categorized the issues for millimeter wave penetration into millimeter wave introduction areas, millimeter wave compatible base station equipment, millimeter wave implementation terminals, and millimeter wave use cases. In a sense, the current situation is thought to be creating a negative chain reaction. For example, if there are no use cases that take advantage of the high speed and large capacity unique to millimeter wave, it is not possible for mobile network operators to anticipate the cost-effectiveness of introducing millimeter wave by considering an increase in the number of users/ARPU. This is one of the reasons why they are reluctant to expand their area. The reason why the number of terminals supporting millimeter wave is limited is that the millimeter wave area is limited. The reason why millimeter wave specific use cases have not been created is probably that the millimeter wave area is limited and millimeter wave supporting terminals are not widespread. Therefore, for the spread of millimeter wave, it is necessary to solve all the above three issues and make it a positive chain reaction(Fig. 3-3).

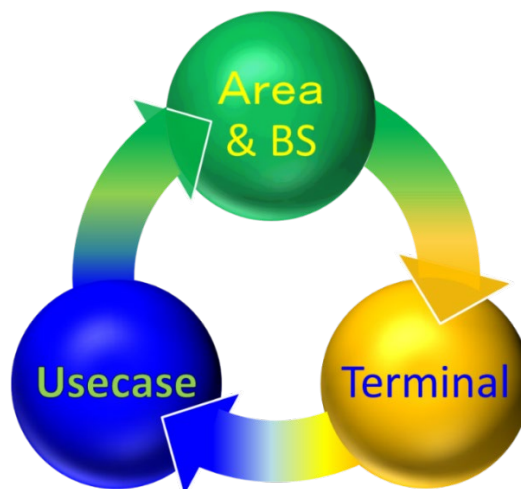

Fig. 3-3 Cross-correlation and positive chain for wide spread of mm-wave

Furthermore, the above-mentioned millimeter wave situation and issues are not only domestic issues, but global issues. The situation of overseas is even more serious. Although millimeter wave frequency allocation is gradually spreading overseas, it is still limited to some countries. Even in countries where millimeter wave frequencies have been allocated, they have not been deployed in areas, or have been introduced only in a limited number of areas and for a limited number of applications. There was a case where the granted license was revoked due to a situation in which the area had not yet been expanded. For the dissemination of millimeter wave, price reduction, cost reduction, and technological innovation by building an ecosystem on a global scale are essential. In the future, it will be extremely important to share the problems and solutions of millimeter wave with the rest of the world and to build a global ecosystem to disseminate millimeter wave in Japan.

#### **References**

- [1] Kazutaka Toyotake, et al., “Human body shielding loss in the terahertz band,” IEICE General Conference, B-1-5, Mar. 2022

## 4. Millimeter wave technology overview

This chapter provides an overview of the technologies that are considered effective in solving the problems of widespread use of millimeter wave, as described in Chapter 3, and millimeter wave related technologies that have been specified or are being considered for specification in standardization such as 3GPP. Fig. 4-1 summarizes the 11 millimeter wave technologies discussed in this chapter and the challenges to be solved.

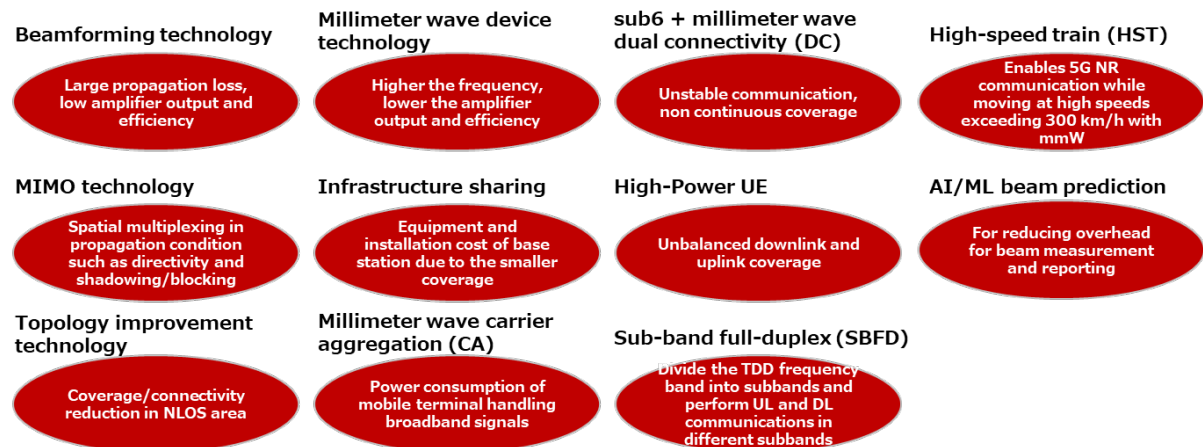

Fig. 4-1 Millimeter wave technology and challenges to be solved

### 4.1 Beamforming technology

Beamforming is an essential technology for millimeter wave to solve the problem of large propagation loss and lower amplifier output and efficiency. As shown in Fig. 4-2, by using a multi-element array antenna in the base station, a high array gain can be obtained, which can solve the problem of propagation loss [1]. In addition, by using the same number of amplifiers as the antenna elements of the multi-element array antenna or in proportion to the number of elements, the problem of low output and efficiency per amplifier can be overcome. On the other hand, if the array gain is increased by increasing the number of antenna elements, the beam width becomes narrower. It is required to enable better beam directivity and tracking control. An increase in array gain by a multi-element array antenna is effective not only for downlink coverage but also for uplink coverage expansion.

Beamforming methods are classified into analog beamforming, digital beamforming, and hybrid beamforming [1]. Due to the need for a large number of antenna elements and wider bandwidth, analog beamforming is commonly used for millimeter wave. This is because high-speed DACs/ADCs that support wideband consume a lot of power consumption, so analog beamforming, which requires the least number of DACs/ADCs (the same number as the number of multiplexed signals), is suitable.

It is common to use a VH polarization for multiplexing two transmissions from one antenna panel. In order to accommodate future traffic increases and further enhance the usefulness of millimeter wave, it is necessary to increase the multiplexing number of millimeter wave more than two. Using a plurality of antenna panels is one option to increase the number of multiplexes. In 3GPP, Rel-17 standardizes uplink multibeam control for terminals equipped with multi-panels, and Rel-18 further standardizes simultaneous multibeam transmission on uplink for millimeter-wave fixed mobile station terminals (CPE, FWA, etc.) [2].

In base stations, the introduction of multibeams using multiple panels is optional. But in this case, the area of the array antenna and the number of circuits such as amplifiers increase. There is also a method of dividing one antenna panel and using a plurality of divided small-scale antenna panels, but this method reduces the array gain. Therefore, by developing a millimeter wave RF chip capable of multi-beam multiplexing, which has a function to amplify multiplexed signals together with a single amplifier, multiplexed signals other than VH polarization can be transmitted from a single antenna panel [2]. In the future, if the power consumption of high-speed DAC/ADC can be reduced, it will be possible to increase the multiplexing number by applying digital beamforming and hybrid beamforming even to millimeter wave.

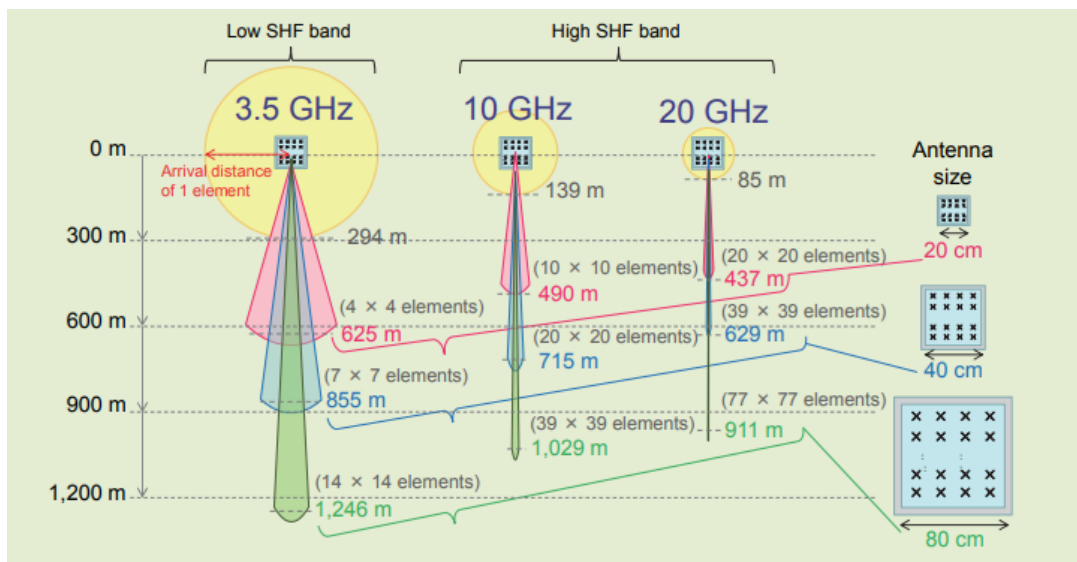

Fig. 4-2 Beamforming effect

## 4.2 MIMO technology

In this section, we introduce solutions for radio wave propagation issues such as directivity and shadowing/blocking of millimeter wave, and future MIMO-related technologies that utilize spatial multiplexing.

### 4.2.1 LoS-MIMO

Spatial multiplexing of MIMO is realized by forming independent paths on the propagation channel by signal processing. In a multipath fading environment, the propagation channel has higher probability to facilitate independent paths. In high-frequency bands such as millimeter wave, where radio waves travel in a straight line and are less likely to be reflected or diffracted, transmitting and receiving antennas are likely in a line-of-sight (LoS) environment, and hence the correlation of propagation channels becomes high. In line-of-sight MIMO (LoS-MIMO), by properly arranging MIMO antenna elements with respect to transmission and reception distances, it is possible to reduce the correlation of propagation channels and form multiple independent paths. In particular, when the element spacing is optimal, communication using MIMO eigenmode transmission becomes possible [3]. However, since the optimum element spacing is determined by the transmission/reception distance, the use in fixed communication has been conventionally studied. In recent years, it is expected to be used in mobile communications, and studies are being conducted on LoS-MIMO, which is robust to fluctuations in transmission and reception distances [4]. These LoS-MIMO technologies make it easier to use spatial multiplexing even in millimeter wave, making it possible to improve the frequency utilization efficiency of millimeter wave.

### 4.2.2 Massive-MIMO/Distributed-MIMO

Millimeter wave has a high directivity, and there is a risk that communication will be interrupted if radio waves are blocked by obstacles. As a countermeasure, distributed MIMO (Distributed-MIMO), which increases the probability of line-of-sight communication from remote antenna units (RAUs) to user terminals by distributing many RAUs, is effective, as shown in Fig. 4-3 [5-7]. In particular, the introduction of wide-area Distributed-MIMO, in which multiple RAUs connected to a central base station are installed outdoors on utility poles, traffic lights, street lights, etc., and indoors on walls, ceilings, etc., and these multiple RAUs coordinate with each other is expected [8]. Wide-area Distributed-MIMO enables user terminals to secure line-of-sight paths with multiple RAUs, thereby enhancing the reliability of millimeter wave communications.

Distributed-MIMO is a technology that maximizes degree of freedom in spatial domain by securing independent propagation paths by arranging the antenna elements of an array antenna at a greater distance than the carrier wavelength.

There are two options for Massive-MIMO; one option is to arrange antenna elements with the element spacing close to about 1/2 wavelength, which has already been adopted in practical use in the sub6 band, and the aforementioned Distributed-MIMO. The former can generate a steerable plane wave beam, but the degree of spatial domain multiplexing depends on the number of independent propagation paths. The latter cannot generate a steerable plane wave beam, but likely to have independent paths.

However, it has the feature of maximizing the spatial multiplicity. In 3GPP, Rel-16/17 specifies Distributed-MIMO using two transmission and reception points (Also called as TRP: Transmission and Reception Points) on the base station side for one UE [10].

As for Multi-TRP, Rel-18 is also being advanced by introducing specifications for simultaneous communication with multiple TRPs that control the beam independently [2].

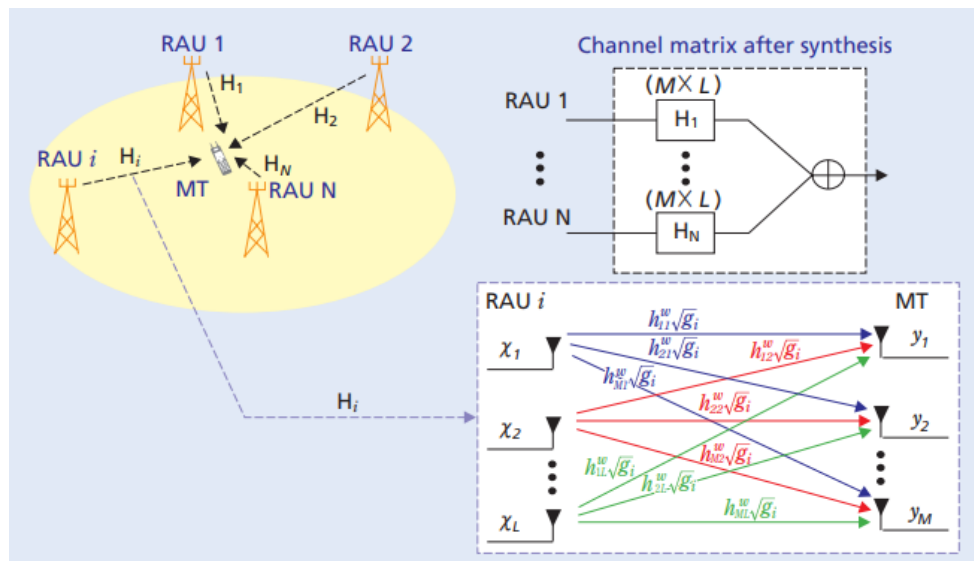

Fig. 4-3 Channel matrix from transmitters to receiver



### 4.3 Topology improvement technology

An issue of millimeter wave is coverage/connectivity in areas that has no line-of-sights from the base station. Therefore, installing a relay station or a reflector between the base station and a user terminal makes it possible to improve the performance in areas that are out of line-of-sight from the base station. Relay stations are classified into regenerative relay stations and non-regenerative relay stations such as repeaters. Repeaters requires only power supply basically and hence are easy to install in both outdoor and indoor without GPS signals. Further, Repeaters amplify and forward the signal without digital signal processing and therefore, the delay caused by a Repeater is not high. Since the millimeter wave band repeater supports beamforming (antenna integrated), the donor-side unit facing the base station and the service-side unit facing the terminal are separated, and the units are connected with a single coaxial cable. This enables flexible deployment and area construction [11]. On the other hand, since TDD operation is common for millimeter wave and beam control is essential, it is desirable to be able to relay while correctly controlling whether to relay the upper and lower links and whether to perform beam control for the base station or the mobile station. Therefore, in 3GPP, as shown in Fig.4-4, a non-regenerative relay station called Network controlled repeater (NCR), which adds TDD pattern and beam control functions to the repeater, is standardized in Rel-18 [12].

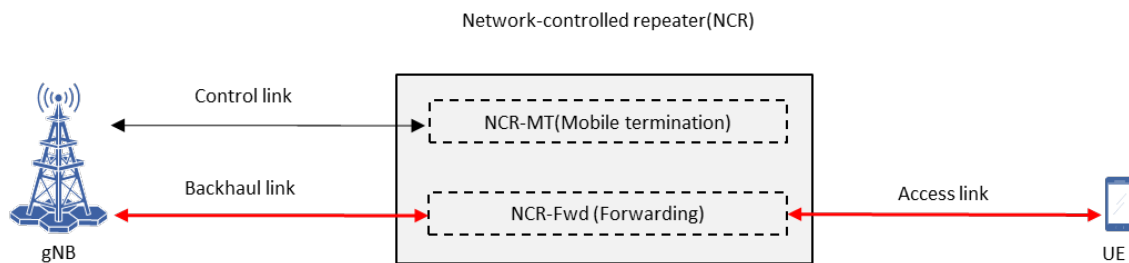

Fig. 4-4 Network controlled repeaters [13]

As a regenerative relay station, IAB (Integrated Access and Backhaul) has been standardized in Rel-16 in 3GPP. As shown in Fig.4-5, IAB is a node that has functions equivalent to base station DU and functions equivalent to mobile stations. Since Rel-16, various protocols and control signals for IAB control have been prescribed.

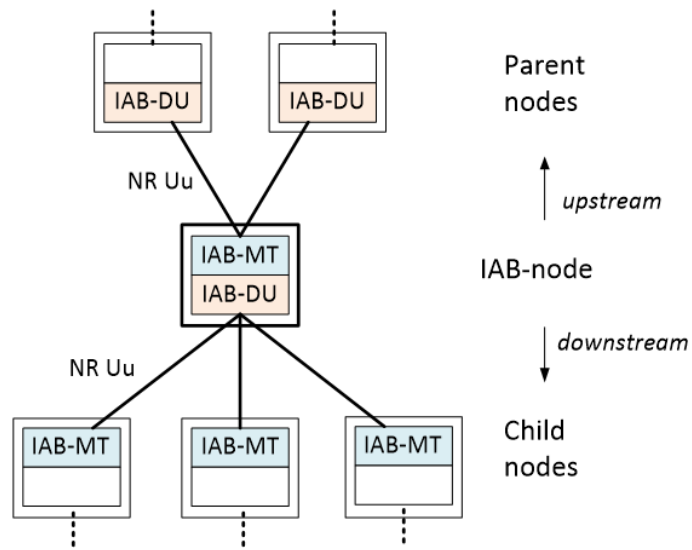

Figure 4.7.1-2: Parent- and child-node relationship for IAB-node

Fig. 4-5 IAB-node [14]

On the other hand, since it is considered that there are cases where it is desirable to realize relay without introducing IAB nodes, it was agreed that Rel-19 will consider a new node with the entire function of the base station and the function of a mobile station, WAB (Wireless Access and Backhaul) [15]. As a form of WAB, as shown in Fig. 4-6, a use case in which the functions of the entire base station are mounted on a moving body such as a train or a flying object and the communication between the ground station and the terminal of the passenger is relayed.

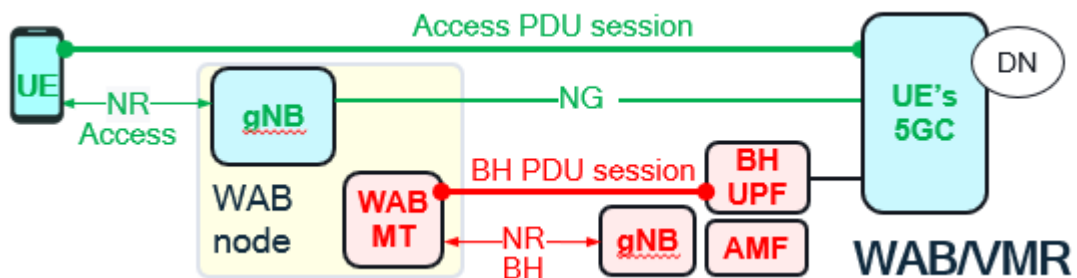

Fig.4-6 WAB-node [16]

Recently, methods to control the radio environment dynamically are extensively studied. As shown in Fig. 4-7, these include RIS (Reconfigurable Intelligent Surface), which controls the position and orientation of relay stations, and the direction of reflecting waves in arbitrary directions using metasurface reflectors [11, 17]. In addition, some other technologies are also studied such as a technology that bypasses blocking objects with a dielectric waveguide that enables low-loss transmission compared to coaxial cables, radiates radio waves from a part of the dielectric waveguide, and freely changes and moves the radiation position of radio waves. As a result, area creation technology that can flexibly respond to changes in the radio wave environment, such as changes in the layout of factories, is being studied [12].

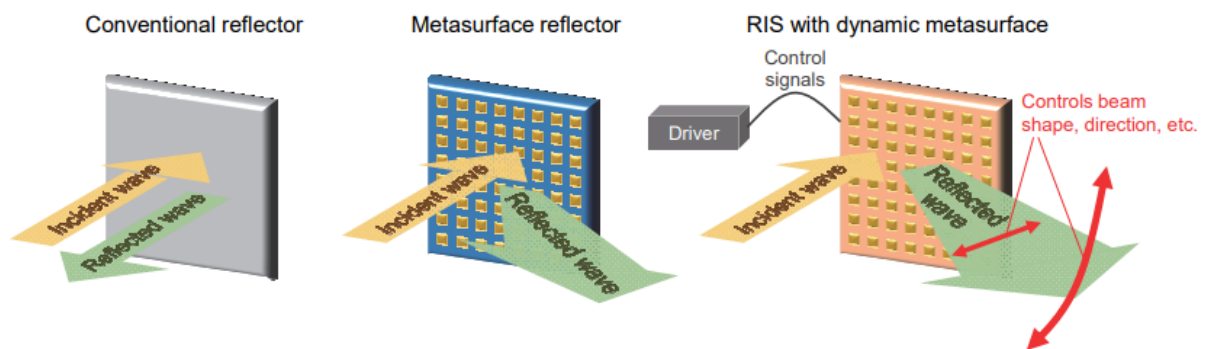

Fig. 4-7 Conceptual diagram of RIS using metasurface technology

#### 4.4 Millimeter wave device technology

Here, we consider device-related technology that solves the problem of low amplifier output and efficiency in millimeter wave. Fig. 4-5 shows the relationship between frequency and amplifier output for various device materials. As can be seen from the figure, the higher the frequency, the lower the output of the amplifier. At high frequencies above the 28 GHz band, the output of amplifiers made of CMOS or SiGe drops significantly. By using GaN as a device material, it is possible to increase the output even for millimeter wave, but since GaN is more expensive than CMOS, current millimeter wave base stations use multi-element array antennas and CMOS or SiGe as materials. Therefore, if the cost of GaN decreases in the future, it will be possible to realize millimeter wave base stations with various configurations other than multi-element array antennas by using high-power amplifiers.

Next, consider the problem that the efficiency of the amplifier decreases as the frequency increases. In the sub6, DPD (Digital Pre-Distortion) is applied to the Doherty amplifier, which greatly improves the efficiency of the amplifier. DPD is not used for millimeter wave so far since the requirement for ACLR (Adjacent Channel Leakage Ratio) for millimeter wave is less strict. However, DPD would also be beneficial for millimeter wave since it can compensate for signal distortion and hence reducing EMV (Error Vector Magnitude), enabling 256QAM transmission, and reducing power backoff to improve amplifier efficiency. In millimeter wave base stations using multi-element antennas, it is necessary to get feedback from many amplifiers using many high-speed ADCs over broadband channel, which increases the circuit complexity and power consumption of DPDs. Therefore, a technology is being studied to reduce the DPD circuit complexity by exploiting the relaxed ACLR regulations for millimeter wave to reduce the number of high-speed ADCs used for feedback [13].

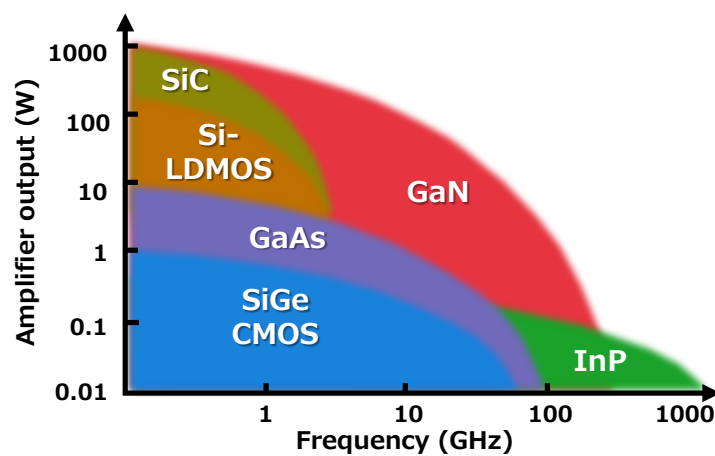

Fig. 4-8 Relationship between frequency and amplifier output

#### 4.5 Infrastructure sharing

Since millimeter wave has relatively smaller coverages, it is necessary to install a large number of base stations in order to cover a wide area. Therefore, it is an important issue to keep the equipment cost and installation cost of the base station low. Infrastructure sharing is considered to be one of the effective means to solve these problems [20]. As shown in Fig. 4-9, there are various infrastructure sharing methods, which involves sharing installation locations such as steel towers and antenna facilities, and sharing base stations [21]. Sharing network facilities of other mobile operators such as roaming and MVNOs (Mobile Virtual Network Operators), has already been implemented. At low frequencies such as sub6, many base stations separate the radio unit (amplifier) and antenna via the RF port, so it is relatively easy to share the antenna. On the other hand, since millimeter wave has a large power loss due to transportation from radio unit to antennas, legacy antenna sharing, which requires a long distance between an amplifier and an antenna, is not suitable. Especially for outdoor scenarios where coverage is more important, sharing of base stations or radio units would be suitable for millimeter wave. Such practical application is being studied [21]. In addition, in high frequency bands such as millimeter wave, where wide bandwidths can be allocated, a base station configuration is being studied in which signal processing functions of radio units are consolidated to a central station using analog RoF (Radio-over-Fiber), and a radio unit comprising an antenna and an amplifier is shared by a plurality of wireless systems [22]. As a result, it is possible to improve the ease of installation and economic efficiency by reducing the size and power consumption of distributed radio units.

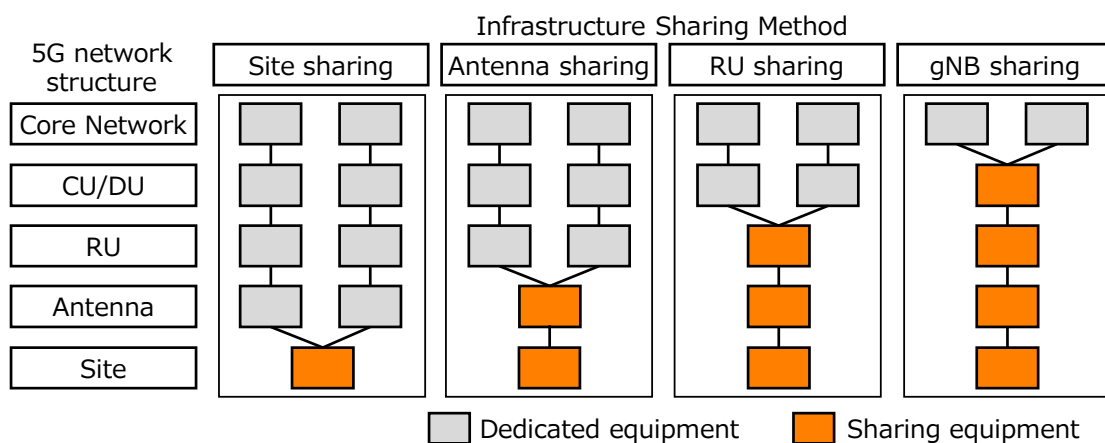

Fig. 4-9 Infrastructure sharing methods

#### 4.6 Millimeter wave Carrier Aggregation (CA)

In general, communication over millimeter wave uses a wider bandwidth than sub6. For example, in the 28GHz band available in Japan, 400MHz is allocated per 5G operator, and up to 900MHz continuous frequency is available for Local 5G. In many cases, rather than treating such a wideband as a single carrier, a form of carrier aggregation (CA) is applied, in which multiple carriers with a bandwidth of 100 MHz are aggregated for communication with a terminal [10]. CA can flexibly and adaptively change the number of carriers used for communication. In CA, it is also possible to use different numbers of carriers for downlink and uplink (see Fig. 4-10). For example, power consumption of the mobile station can be suppressed by controlling the number of carriers based on the required throughput or the like. Millimeter wave CA has been standardized by 3GPP for all 5G millimeter wave frequency bands, including the 28 GHz band, and is an essential technology for millimeter wave operations today.

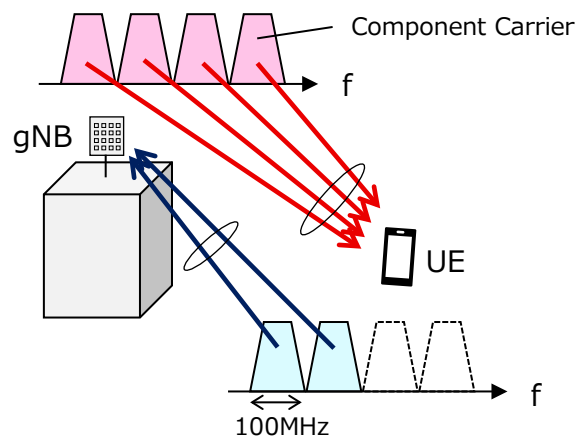

Fig. 4-10 Millimeter wave carrier aggregation (CA)

#### 4.7 sub6 + millimeter wave Dual Connectivity (DC)

In 5G, the sub6 carrier can be used as an anchor carrier for millimeter wave communication, and sub6 + millimeter wave dual connectivity (DC), which provides 5G services through simultaneous communication of sub6 and millimeter wave, can be used [10, 23]. With sub6+millimeter wave DC, both sub6 and millimeter wave communications can be used simultaneously, so higher throughput can be achieved than when only millimeter wave is used. In addition, even in areas where there is no continuous coverage with millimeter wave or when millimeter wave communications are unstable, connections can be maintained using the sub6 frequency, reducing the probability of radio link failures caused by a lack of coverage for millimeter wave. In sub6+millimeter wave DC, use of an LTE carrier as anchor for 5G is called NSA (Non-Standalone), and it has become an essential technology especially for the initial deployment and early operation of 5G (see Fig. 4-11). Sub6+ millimeter wave DC (including NSA) has been standardized by 3GPP [24] so that it can be implemented in various combinations of frequencies of each country and operator, and is a widely used technology today.

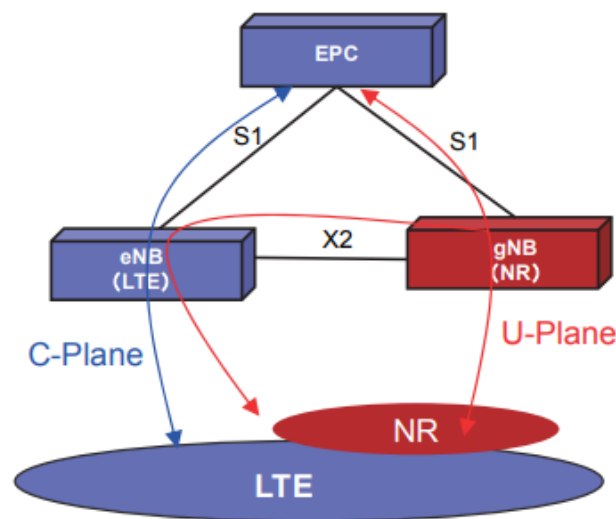

Fig. 4-11 Concept of LTE-NR dual connectivity

#### 4.8 High-Power UE (HPUE)

For millimeter wave and sub6, maximum outputs at mobile station are defined. In general, mobile station output power is smaller than the base station output power, which poses a problem of coverage imbalance between downlink and uplink. To solve this problem, high-power mobile stations called HPUE (High-Power User Equipment) have been standardized [25]. Under the control of the base station, HPUE can improve uplink coverage by increasing power output within a range that does not cause problems. Several types of HPUE have been standardized for millimeter wave. For example, HPUE called Power Class 1 is a mobile station specification for fixed radio, and can output a maximum EIRP of 55 dBm. Millimeter wave HPUE of Power Class 1 has also been commercialized in the United States.

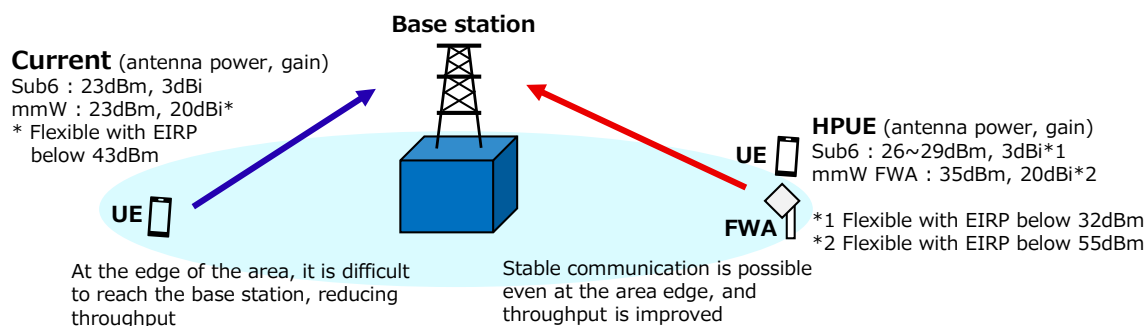

Fig. 4-12 Introduction of HPUE [20]

#### 4.9 Sub-band full-duplex (SBFD)

In cellular communications, TDD is generally used at high frequencies, including millimeter wave. TDD does not require the division of the upper and lower link frequencies, which increases efficiency, but it also requires the synchronization of the upper and lower link switching patterns at the same frequency or adjacent frequencies. In general, downlink has a higher traffic volume than uplink link, so TDD's upstream link bias pattern is used for TDD upstream links. However, in this case, there is a problem that the delay of uplink communication is limited because the transmission timing of the uplink link is limited.

In 3GPP, Sub-band full-duplex (SBFD), a base station that communicates at the TDD frequency divides its frequency band into subbands, and performs vertical link communication in different subbands, was studied in Rel-18 [27]. The synchronization of the upper and lower link communication, which was considered essential for TDD, is disrupted, resulting in significant interference.



In particular, in a base station that simultaneously performs upstream link communication, self-interference in which its own downlink transmission interferes with its own upstream link reception is very large, and this suppression is essential. In the study at Rel-18, it was clarified that performance improvement by lowering the latency of the uplink can be expected if self-interference is suppressed by providing a guard frequency between the subbands, dividing the base station antenna panel for simultaneous vertical link communication into upper and lower subpanels (Fig. 4-13), and introducing interference cancellers in RF and baseband. In addition, it may be necessary to take separate measures depending on the environment regarding the point that TDD synchronization between base stations, mobile stations, and adjacent frequencies is disrupted. It has been agreed that SBFD will be standardized on Rel-19.[28]

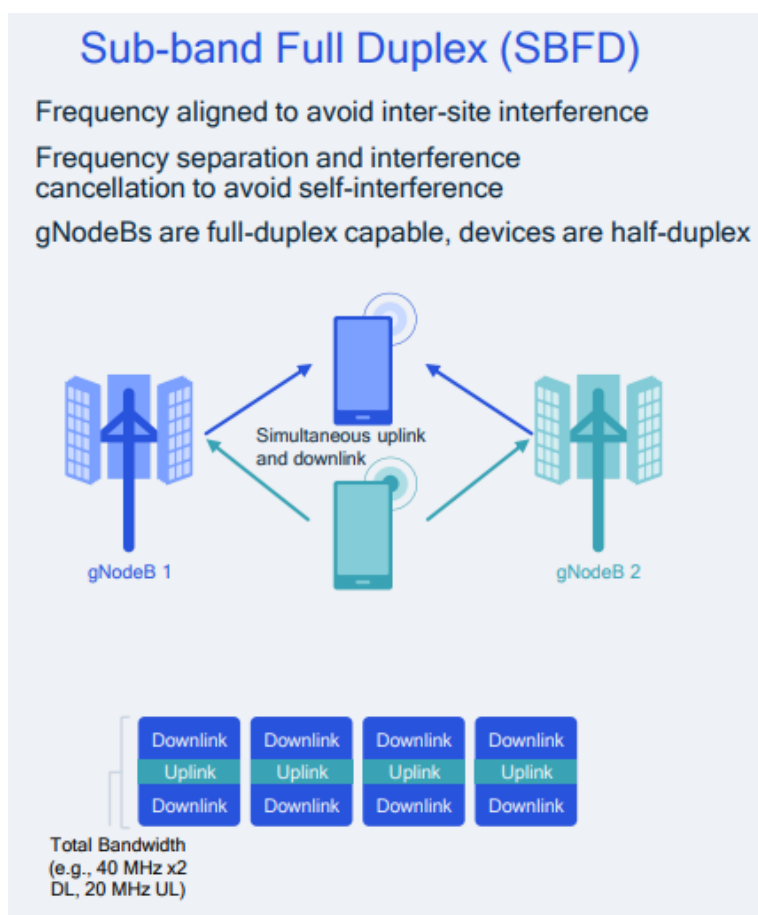
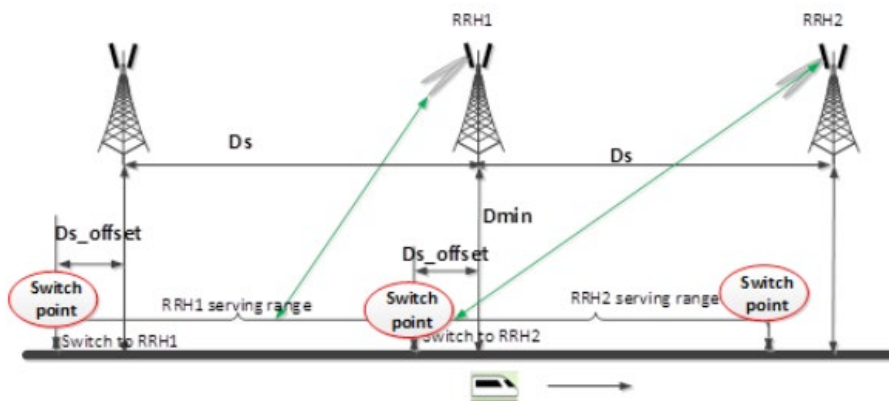

Fig. 4-13 Sub-band full-duplex (SBFD) [29]

#### 4.10 High-speed train (HST)

In 3GPP, HST is standardized as a function that realizes 5G NR communication during high-speed travel exceeding 300 km/h. On Rel-16, only the sub-6 HST was standardized, but on the Rel-17, the millimeter-wave HST was also standardized. Considering the realistic operation of millimeter wave, it is unlikely that each passenger's terminal will communicate with a ground base station while beam controlling while traveling at high speed with millimeter wave. Therefore, in millimeter-wave HST, assuming a scenario in which a terminal fixed on the roof of a vehicle communicates with a ground base station, such a terminal is newly defined as a Power class 6 terminal, and its functions and performance regulations are standardized [30].

As shown in Fig.4-14, millimeter-wave HST is a Uni-directional deployment in which the base stations in front of the direction of travel of the high-speed moving terminal switch one after another, and Bi-directional deployment in which the base stations in front and rear of the direction of travel switch one after another.



(a) Uni-directional deployment

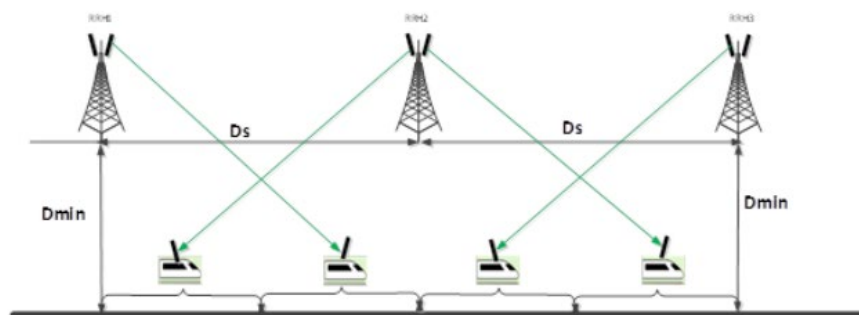

(b) Bi-directional deployment

Fig. 4-14



Provided by JR Central

Fig. 4-15 An example of a use case in high-speed rail

#### 4.11 Use of AI/ML (AI/ML for beam management)

In beam management, which is essential for 5G millimeter wave, the base station transmits reference signals such as SSB and CSI-RS with multiple candidate transmission beams and requests the terminal to measure and report. The terminal measures these reference signals with multiple candidate reception beams, determines the reception beam, and reports the measurement results to the base station. The base station decides the transmission beam to be used based on the report from the terminal and notifies the terminal. By repeating this measurement and reporting, the optimal use of transmission and reception beams can be maintained, ensuring communication quality. It is desirable to always use the optimal transmission and reception beams, but the more candidate beams there are, or the greater the changes in the propagation environment due to terminal movement, the more frequent and detailed beam measurement and reporting are required, increasing overhead.

In Rel-18, a study on beam prediction using AI/ML was conducted to solve this problem. The set of downlink transmission beams used for communication is defined as beam set A, and the set of downlink transmission beams used for measurement is defined as beam set B. Based on the measurement of beam set B, AI/ML is used at the base station or terminal to predict the optimal beam from beam set A. The following two cases of beam prediction using AI/ML were considered.

##### BM-Case1: Spatial domain beam prediction

Beam set B is assumed to consist of fewer beams than beam set A. For example, beam set B may be a subset of the beams included in beam set A (see Fig. 4-16), or it may consist of beams with a wider beamwidth than those included in beam set A.

If the optimal beam can be identified from beam set A based on the measurement of beam set B, beam management can be achieved with less overhead compared to measuring the beams included in beam set A.

##### BM-Case2: Temporal beam prediction

Beam set B is assumed to consist of fewer beams than beam set A, or both sets are identical. If the optimal beam at the present time or in the future can be identified from beam set A based on past measurements and their temporal changes of beam set B, the frequency of beam measurements can be reduced, achieving beam management with less overhead.

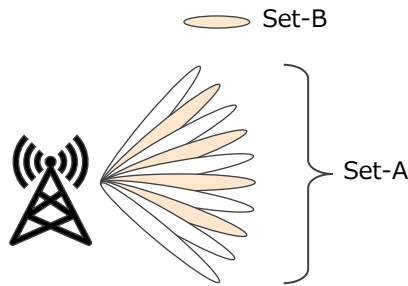

Fig. 4-16 Example of Beam Set A and Beam Set B (Determining the optimal beam from Beam Set A based on the measurement of Beam Set B using AI/ML)

In either case, beam prediction using AI/ML is assumed to be performed on either the base station side or the terminal side. When beam prediction using AI/ML is performed on the base station side, the results of beam measurements reported by the terminal are input into the AI/ML model to predict and determine the optimal beam. To make accurate predictions, it is necessary to pre-train the AI/ML model with various data. If each base station can independently train the AI/ML model, it will be possible to implement beam prediction suitable for the implementation and operational parameters/environment of each base station. When beam prediction using AI/ML is performed on the terminal side, the terminal inputs the beam measurement results into the AI/ML model to infer and determine the optimal beam. In this case, it is possible to perform learning and prediction considering the unique implementation of each terminal. Since the transmission beam patterns and their reception quality by the base station are assumed to vary depending on the implementation, operational parameters, and communication environment of the base station, it is desirable to conduct AI/ML learning on the terminal side considering the existence of various base station implementations and operational parameters/environments.

3GPP has verified the effectiveness of beam prediction using AI/ML in the millimeter wave (30 GHz band) through computer simulations and compiled the results into a report. Here are some excerpts from the summary of the results:

- In BM-Case1, using AI/ML can reduce the overhead related to beam measurement to 1/4 to 1/16 compared to measuring all beams in set A. Even when the overhead of beam measurement is reduced to 1/4 or 1/8 using AI/ML, it has been reported that the average user throughput can achieve more than 85% and the 5% cell edge user throughput can achieve more than 70% compared to measuring all beams in set A.
- In BM-Case2, the longer the beam prediction period, the higher the prediction accuracy. It is also possible to reduce the overhead related to beam measurement to 1/2 to a maximum of 1/5 while ensuring a certain level of communication quality.

Based on the above Rel-18 Study, 3GPP has agreed to standardize Beam management using AI/ML in Rel-19. The scope of standardization is expected to include signaling and performance specifications between base stations and terminals to realize beam prediction using AI/ML, but standardizing the AI/ML model itself is not being considered.

## References

- [1] NTT DOCOMO Technical Journal, Vol.17, No.4, PP.29-39, Apr. 2016.  
[https://www.docomo.ne.jp/english/binary/pdf/corporate/technology/rd/technical\\_journal/bn/vol17\\_4/vol17\\_4\\_004en.pdf](https://www.docomo.ne.jp/english/binary/pdf/corporate/technology/rd/technical_journal/bn/vol17_4/vol17_4_004en.pdf)
- [2] 3GPP RP-223276, WID Update: MIMO Evolution for Downlink and Uplink
- [3] Fujitsu, "RU Technologies," PP.4, 2023.  
<https://www.fujitsu.com/global/images/gig5/RU-Technologies.pdf>
- [4] K. Nishimori, et al., "On the Transmission Method for Short-Range MIMO Communication," IEEE Trans. Vehicular Tech., 2011.
- [5] M. Palaiologos, M. H. C. Garcia, R. A. Stirling-Gallacher and G. Caire, "Design of Robust LoS MIMO Systems with UCAs," 2021 IEEE 94th Vehicular Technology Conference (VTC2021-Fall), Norman, OK, USA, 2021, pp. 1-5.
- [6] NTT DOCOMO Technical Journal, Vol.9, No.1, PP.62-66, June 2007.  
[https://www.docomo.ne.jp/english/binary/pdf/corporate/technology/rd/technical\\_journal/bn/vol9\\_1/vol9\\_1\\_062en.pdf](https://www.docomo.ne.jp/english/binary/pdf/corporate/technology/rd/technical_journal/bn/vol9_1/vol9_1_062en.pdf)
- [7] NEC, "Millimeter-wave distributed-MIMO technique triples the number of simultaneous connections and transmission capacity in a real office setting," Jan. 2021  
[https://www.nec.com/en/press/202101/global\\_20210125\\_01.html](https://www.nec.com/en/press/202101/global_20210125_01.html)
- [8] KDDI Research Institute, "World's first successful demonstration of wireless network deployment methodology for Beyond 5G," Oct. 2021.  
<https://www.kddi-research.jp/english/newsrelease/2021/100701.html>
- [9] NTT/DCOMO/NEC, "World's first successful demonstration of distributed MIMO that continues wireless connections in the 28 GHz band by eliminating shielding issues," Oct. 2022.  
<https://group.ntt/en/newsrelease/2022/10/31/221031a.html>
- [10] 3GPP TS 38.300, v17.3.0
- [11] DKK, "Repeater, Metamaterial reflector panels (28GHz)," <https://denkikogyo.co.jp/en/elec/product/mobile/l5g/>
- [12] 3GPP RP-230175, Revised WID on NR network-controlled repeaters, ZTE
- [13] 3GPP TR38.867
- [14] 3GPP TS38.401
- [15] 3GPP RP-234041, New SID: Study on additional topological enhancements for NR, AT&T
- [16] 3GPP RP-233021, Rel-19 Views on Additional Topology Enhancements, Qualcomm

- [17] NTT DOCOMO Technical Journal, Vol.23, No.2, PP.14-23, Oct. 2021.  
[https://www.docomo.ne.jp/english/binary/pdf/corporate/technology/rd/technical\\_journal/bn/vol23\\_2/vol23\\_2\\_003en.pdf](https://www.docomo.ne.jp/english/binary/pdf/corporate/technology/rd/technical_journal/bn/vol23_2/vol23_2_003en.pdf)
- [18] NTT DOCOMO Technical Journal, Vol.23, No.3, PP.5-12, Jan. 2022.  
[https://www.docomo.ne.jp/english/binary/pdf/corporate/technology/rd/technical\\_journal/bn/vol23\\_3/vol23\\_3\\_002en.pdf](https://www.docomo.ne.jp/english/binary/pdf/corporate/technology/rd/technical_journal/bn/vol23_3/vol23_3_002en.pdf)
- [19] T. Ota, et al., “An Experimental Study on Multibeam Digital Predistorter with Intercarrier Interference Suppression,” in Proc. IEEE VTC2022-Fall, 2022.
- [20] TEPCO Power Grid, “Final summary material for public opinion exchange meeting for future 5G base stations,” Feb. 2022. (Japanese only)  
<https://www.tepco.co.jp/pg/company/press-information/information/2022/pdf/220204a.pdf>
- [21] JTOWER, “JTOWER and Foxconn entered into the agreement to develop a shared radio unit compatible with 5G millimeter wave,” Apr. 2022.  
[https://en.jtower.co.jp/en\\_news/2022/14525/](https://en.jtower.co.jp/en_news/2022/14525/)
- [22] NTT, “Efficiently Accommodating High-frequency-band Wireless Systems by Using Analog Radio-over-fiber,” Mar. 2020.  
[https://www.rd.ntt/e/research/JN20200315\\_h.html](https://www.rd.ntt/e/research/JN20200315_h.html)
- [23] NTT DOCOMO Technical Journal, Vol.22, No.2, PP.23-39, Oct. 2020.  
[https://www.docomo.ne.jp/english/binary/pdf/corporate/technology/rd/technical\\_journal/bn/vol22\\_2/vol22\\_2\\_004en.pdf](https://www.docomo.ne.jp/english/binary/pdf/corporate/technology/rd/technical_journal/bn/vol22_2/vol22_2_004en.pdf)
- [24] 3GPP TS 38.101-3, v17.8.0
- [25] 3GPP TS 38.101-2, v17.8.0
- [26] Published report from Telecommunications council of Ministry of Internal Affairs and Communications (Japanese only)
- [27] 3GPP TR38.858
- [28] 3GPP RP-234035, New WID: Evolution of NR duplex operation: Sub-band full duplex (SBFD), CMCC
- [29] <https://www.qualcomm.com/content/dam/qcomm-martech/dm-assets/documents/setting-off-the-5g-advanced-evolution-with-3gpp-release-18.pdf>
- [30] GPP, RP-233151, Revised WID on enhanced NR support for high speed train scenario in frequency range 2 (FR2), Samsung
- [31] 3GPP TS38.101-4
- [32] 3GPP, TR38.843, Study on Artificial Intelligence (AI)/Machine Learning (ML) for NR air interface (Release 18)
- [33] 3GPP, RP-242399, Revised WID on Artificial Intelligence (AI)/Machine Learning (ML) for NR Air Interface, Qualcomm



## 5 Performance evaluation

In this chapter, we introduce experimental and measurement results using 5G millimeter wave. The results demonstrate that millimeter wave can achieve extremely high throughput and low latency performance and can be utilized in various environments including non-line-of-sight (NLOS) scenario. A summary of each section is as follows:

- Section 5.1: Measurement of 5G millimeter wave throughput and latency performance (one-to-one communication, ideal environment)
  - We measured the throughput and latency of one-to-one communication with various receiving power in a line-of-sight (LOS) environment. It was found that a throughput of 1 Gbps or more can be obtained and a latency (Ping RTT) of 7 ms or less can be achieved even with a low receiving power with a low-order modulation scheme. This result indicates that 5G millimeter wave is suitable for a wide range of broadband communication and low-latency services.
- Section 5.2: 5G millimeter wave indoor environmental measurements
  - We installed a 5G millimeter wave base station in an actual indoor facility and measured the throughput at different locations in the facility. It was found that high throughput is achieved not only in the vicinity of a base station with a direct path, but also in places where the direct path is blocked by a pole. This result indicates that 5G millimeter wave can achieve high throughput over a wide area, even in a real indoor environment where some degree of blockage and distance between base stations and terminals are unavoidable.
- Section 5.3: 5G millimeter wave outdoor environment measurement
  - This section introduces outdoor field measurements, including the results reported in [2]. Fixed and moving measurements were performed at an area in Tokyo where commercial outdoor base stations are actually deployed. It was found that each base station can cover a millimeter wave communication area within a range of about 100m and can achieve higher average throughput even when moving, compared to sub6. This result shows that 5G millimeter wave can provide high user values even in situations where 5G millimeter wave area coverage is not fully continuous to some extent.
- Section 5.4: 5G millimeter wave Challenges and Solutions
  - This section introduces activities and studies to address the 5G millimeter wave challenge, that is to support non-line-of-sight environments [35-39]. These include repeaters, RIS, and applications of dielectric waveguides.

## 5.1 5G millimeter wave throughput and latency performance measurement (one-to-one communication in an ideal environment)

We measured the performance in an ideal one-to-one communication environment using a commercially available millimeter wave capable terminal and a 5G base station emulator. Figure 5-1 illustrates the system for the measurement evaluation. The Keysight E7515B UXM 5G wireless test platform is used as a test platform, and SHARP AQUOS R7 (Qualcomm Snapdragon 8 Gen 1) is used as a terminal for the measurement. The test platform and the terminal communicate using the LTE anchor of band 1 (2.1 GHz band) and the 5G New Radio (NR) millimeter wave (4 component carriers (CCs) with 100MHz bandwidth on each for a total bandwidth of 400 MHz) of band n257 (28 GHz band). The millimeter wave transmitting / receiving antennas of the base station emulator and the terminal are placed inside of an anechoic chamber, and these are on a line-of-sight at a distance of about 1.5 m. The downlink transmission power from the base station emulator is adjustable.

### Performance Evaluation of Available FR2 UEs

#### Commercial use

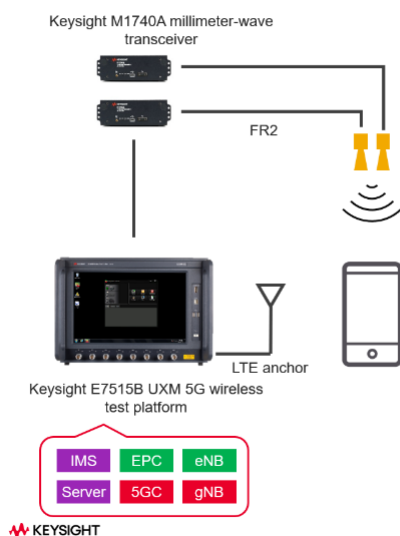

- Connect the UE to a base station emulator.
- Measure the throughput (physical layer) at FR2 by ping packet round-trip time (RTT).
- Set the data exchange at the FR2 NR carrier.

Conditions	
Network Configuration	Non-stand alone (NSA)
LTE	Band 1 (2.1GHz band, LTE anchor)
New Radio (NR)	n257 (28 GHz band; total bandwidth 400 MHz) 100 MHz times 4 CC 2 x 2 multiple-input and multiple-output (MIMO)
Propagation environment	1.5 m line-of-sight environment (LoS)
UE	Smartphones available (Japanese operators)

Fig. 5-1 Performance evaluation of commercial terminal (provided by Keysight)

<Downlink throughput evaluation>

Fig. 5-2 shows the NR physical layer throughput as a function of the downlink power of the base station emulator for a given modulation and coding scheme (MCS) from 256 QAM, 64 QAM, 16 QAM, and QPSK. The throughput does not include the communication over anchor LTE band. Throughput exceeding 3 Gbps with 256 QAM was observed when the received power (RSRP) was sufficiently higher. Also, we could achieve almost error free communication if the RSRP is about -80 dBm or higher. Even when the RSRP is lowered to -110 dBm, it was still possible to communicate at 1 Gbps without errors using 16 QAM. For millimeter wave, the available bandwidth in Japan is typically as wide as 400 MHz for downlink. Therefore, even with low-order modulation, it is possible to provide high throughput.

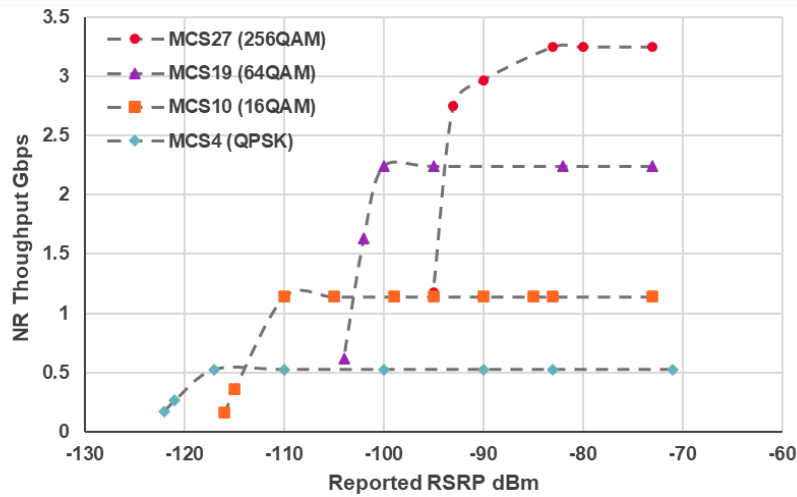

Fig. 5-2 5G millimeter wave throughput

### <5G millimeter wave latency performance>

The NR physical layer throughput and the round-trip delay (Round Trip Time: RTT) measured using ping packets are plotted in Fig. 5-3. In this experiment, the link adaptation feature of the base station emulator was enabled so that it automatically selects the appropriate MCS index to maintain a 10% block error rate. When lowering the downlink receiving power, the average throughput gradually decreases from the peak because the modulation scheme was automatically changed due to the link adaptation. As with the results in the previous section, it was possible to maintain

1 Gbps or more at an RSRP range of -110 dBm or higher. The ping RTT is 5.0 to 5.5ms with the higher RSRP and 6.5ms with the lower RSRP. From these results, the millimeter wave systems can achieve low latency communications regardless of propagation conditions because of the benefits of wide subcarrier spacing and the short time length of a slot, as well as short TDD UL-DL switching cycle.

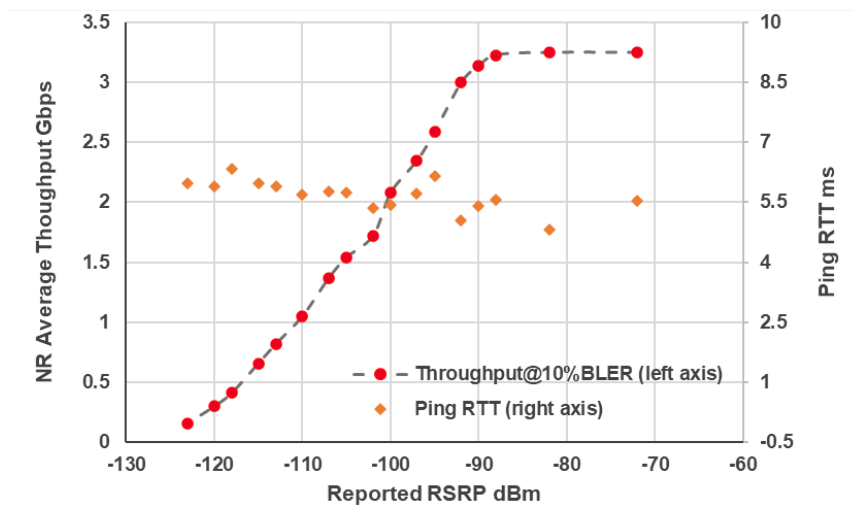

Fig. 5-3 5G millimeter wave throughput and round-trip delay

From the results in section 5.1, we can say that millimeter wave systems have a capability to support both low-latency and high-throughput use cases with the devices that are already available in the market. The measured data also show that it can provide a stable low-latency performance. These results also suggest that millimeter wave networks can be used for applications that do not require peak throughput performance but high-reliability and low-latency (quick responsiveness) such as online gaming.

## 5.2 5G millimeter wave indoor environment measurement

This section presents the performance evaluation results of 5G millimeter wave measured in an indoor environment. We installed a 5G millimeter wave base station in one corner of the 10m x 20m room shown in Fig. 5-4, and measured the downlink throughput at various locations (points A to F) in the room. 2-layer MIMO and 64QAM modulation were used in band n257 (28 GHz band) millimeter wave NR carrier (100 MHz x 4cc totaling 400 MHz), TDD DL:UL ratio = 4:1 and base station transmit power of 32 dBm were assumed. The average throughput was measured over the 5 seconds at each point. The measurement results are follows.

Point A : 1666.54Mbps

Point B : 1586.91Mbps

Point C : 1851.24Mbps

Point D : 1842.28Mbps

Point E : 1602.87Mbps

Point F : 1643.85Mbps

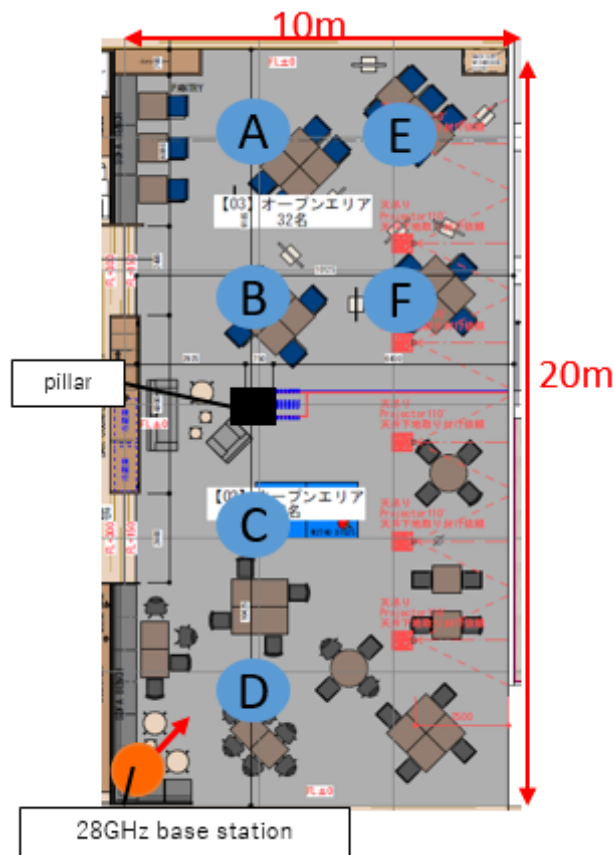

Fig. 5-4 Indoor measurement of 5G mm Wave throughput

When there is no blocking or attenuation in the vicinity of the base station (points C/D), high throughput (over 1.8 Gbps under these measurement conditions/environment) can be obtained. Points A/B/E/F are far from the base station and there is a pillar near the center of the room, so the results at these locations are affected by a certain amount of blocking and attenuation compared to points C/D. However, it can be confirmed that throughput exceeding 1.5 Gbps can still be achieved at all points. This measurement result shows that high throughput can be obtained over a wide range of locations, including non-line-of-sight, even in an actual indoor environment where some degree of blocking and distance between the base station and terminal are unavoidable.

At indoor facilities that have relatively large spaces/areas, such as airports, office buildings, and shopping malls, LTE/5G or wireless LAN is often deployed using DAS (Distributed Antenna System). The reference [1] provides measurement results showing that installing a 5G millimeter wave base stations alongside such DAS base stations or wireless LAN access points can cover a wide range of indoor facilities.

As an example, a visualization of the propagation loss (MPL: Maximum path-loss) from a 5G millimeter wave base station when a 5G millimeter wave base station is collocated with an indoor DAS base station or wireless LAN access point in an airport concourse is shown in Fig 5-5. Each 5G millimeter wave base station has 128 antenna elements for each polarization, and can form 16 horizontal beams. It can be confirmed that the MPL is 115 dB or less in almost the entire area (99.7% of the area). Under the conditions described in [1], throughput of several Gbps can be obtained in 99.7% of the areas. [1] also shows similar measurements in airport concourses, convention centers, subway platforms, offices, and shopping stores.

If DAS and wireless LAN have been installed in the facility, it may be difficult to separately or additionally install a new 5G millimeter wave indoor base stations. [1] reveals that if 5G millimeter wave base stations can be installed alongside an existing indoor network, it is possible to provide 5G millimeter wave services widely even in large-scale facilities.

#### Deploying Indoor mmWave for an Airport Concourse

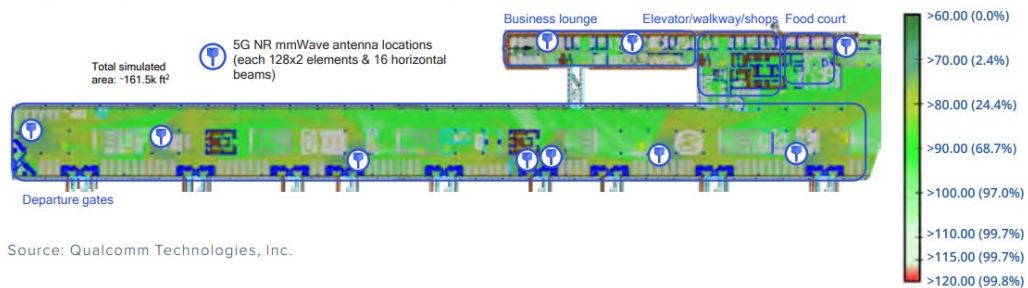

Fig. 5-5 Installation example of 5G millimeter wave base stations at airports and its measurement result [1]

### 5.3 5G millimeter wave outdoor environment measurement

In this section, we introduce the results of a 5G millimeter performance measured in outdoor environment.

#### 5.3.1 Results of uplink throughput measured in outdoor environment

In section 5.3.1, we introduce the results of a 5G millimeter wave performance benchmark survey [2] conducted in Tokyo by Signals Research Group in April 2022 (English version is available in [3] with registration). In the benchmark survey, commercial smartphones that support 5G millimeter wave are used to communicate with commercial 5G millimeter wave base stations installed by operators to measure the achievable throughput, RSRP, and SINR. The bandwidths are 400 MHz for the downlink and 200 MHz for the uplink. With these conditions, the maximum achievable throughput of 5G millimeter wave is over 2.4 Gbps for the downlink and over 400 Mbps for the uplink (2-layer MIMO and 64QAM, respectively).

##### <Fixed point measurement>

In the fixed-point throughput measurement near Shimbashi Station, throughput measurements of over 2 Gbps on the downlink and over 300 Mbps on the uplink were observed. At this time, it was confirmed that the distance between the terminal and the 5G millimeter wave base station serving for the terminal was about 115m. This indicates that millimeter wave can achieve high throughput even when there is a distance of about 100m.

In practice, throughput varies from place to place. Focusing on the uplink, the results of fixed-point measurement of 5G millimeter wave throughput nearby Shimbashi Station were measured and plotted in Fig. 5-6. Four millimeter wave base stations are deployed in this area. It was confirmed that uplink throughput exceeding 150 Mbps can be achieved over a wide area. In some places with a good communication environment, there were cases where the uplink throughput exceeded 250 Mbps.

図9. アップリンク方向における5Gミリ波スループット結果

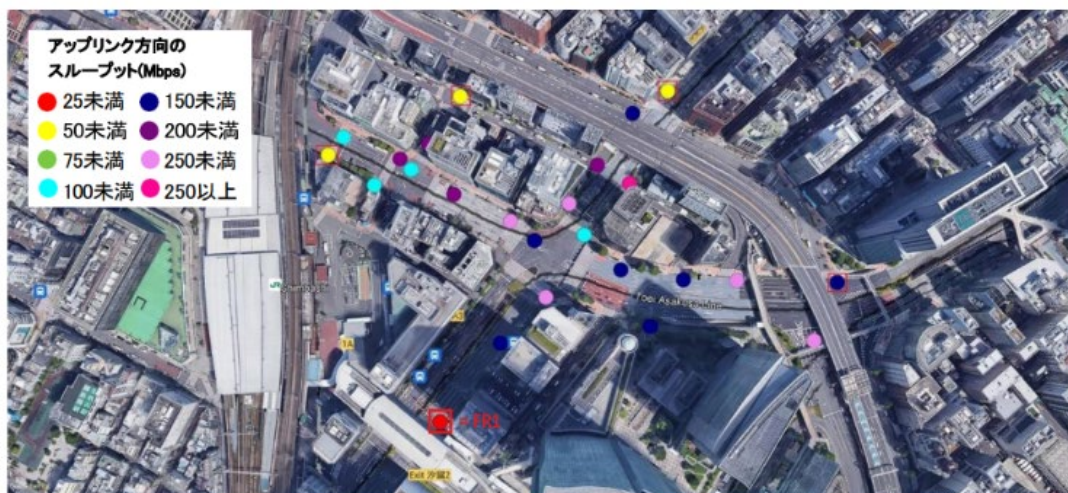

データ: シグナルズ・リサーチ・グループ

Fig. 5-6 Outdoor fixed-point measurement of 5G mm-wave uplink throughput [2]-[3]  
(English version is available in [3] with registration)

<Movement measurement>

The average uplink throughput of walking around Tokyo Station was also measured. In Fig. 5-7, the rightmost graph shows the average throughput when the mobile station's 5G millimeter wave is turned off, and the center shows the average throughput when the mobile station's 5G millimeter wave is turned on and is used. Even if the mobile station's 5G millimeter wave is turned on, millimeter wave communication availability depends on the quality of 5G millimeter wave and is not always available. Each terminal experiences a time/location where 5G millimeter wave is available and a time/location where it is not available. The middle graph shows the average throughput when 5G millimeter wave is not used all the time. For this, when 5G millimeter wave are turned off or in sections where 5G millimeter wave communication is not performed, communication is performed using the 5G sub6 frequency (frequency band n78) instead.



図20.アップリンク方向における移動測定の結果

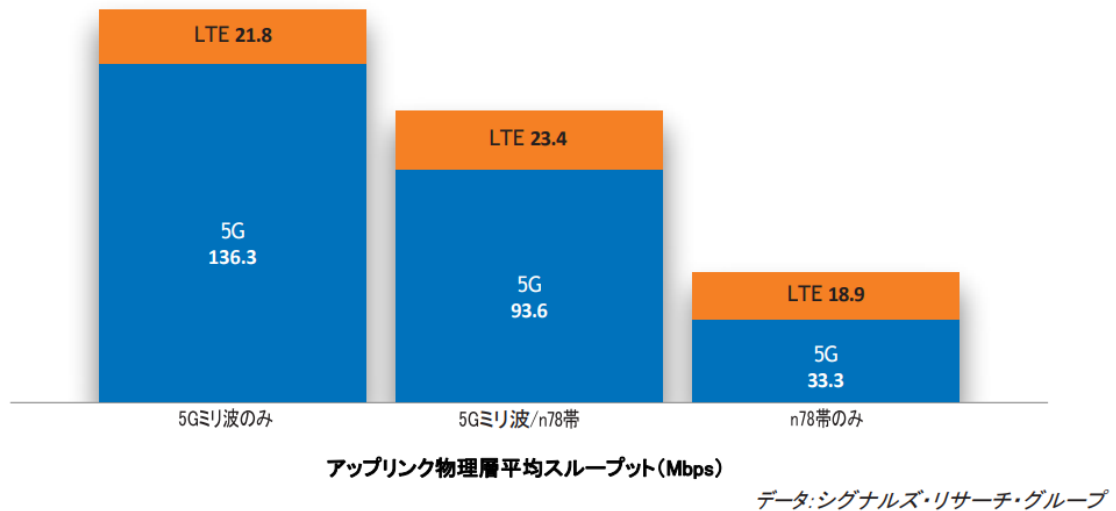

Fig. 5-7 5G millimeter wave uplink throughput mobile measurement outdoors [2]-[3]  
(English version is available in [3] with registration)

These results show that 5G millimeter wave can greatly improve uplink moving average throughput. As mentioned above, the measurement in the middle graph was the case where 5G millimeter wave is not always available. Even so, it is seen that an average uplink throughput of three times can be achieved compared to using only the 5G sub6 frequency band. 5G millimeter wave is sometimes said to be difficult to deploy in areas due to their characteristics of directivity and attenuation, but the results of this measurement show that high user benefits can be obtained even in situations where area coverage is to some extent imperfect. It can be confirmed from the graph on the far left that throughput can be further improved if the deployment of 5G millimeter wave progresses further and communication with 5G millimeter wave becomes possible almost all the time.

On the other hand, for better connectivity/availability of 5G millimeter wave communications, it is necessary to cover areas that are out of line of sight from base stations. The next section introduces some such techniques.

### 5.3.2 Results of downlink throughput and latency measured in outdoor environment

In section 5.3.2, we introduce results of downlink throughput and latency of the 5G millimeter wave commercial networks measured in outdoor environment. The performance was measured in Shibuya, Tokyo in November 2022, by using commercial phones. It was an outdoor walking test to measure the throughput and latency where Ookla® Speedtest® App [4] is used. The Fig.5-8 and Fig.5-9 show the results of throughput and latency measured, in which results of Sub6 and LTE are shown for comparison.

According to Fig. 5-8, the peak and average millimeter wave DL throughputs are 2Gbps and 1Gbps, and they are approximately 4 times and 10 times higher than Sub6 and LTE respectively. And according to Fig. 5-9, the ping latency of millimeter wave is approximately 15msec, which is 1/3 of Sub6 and LTE.



Fig. 5-8 Outdoor walking measurement of 5G mm-wave downlink throughput

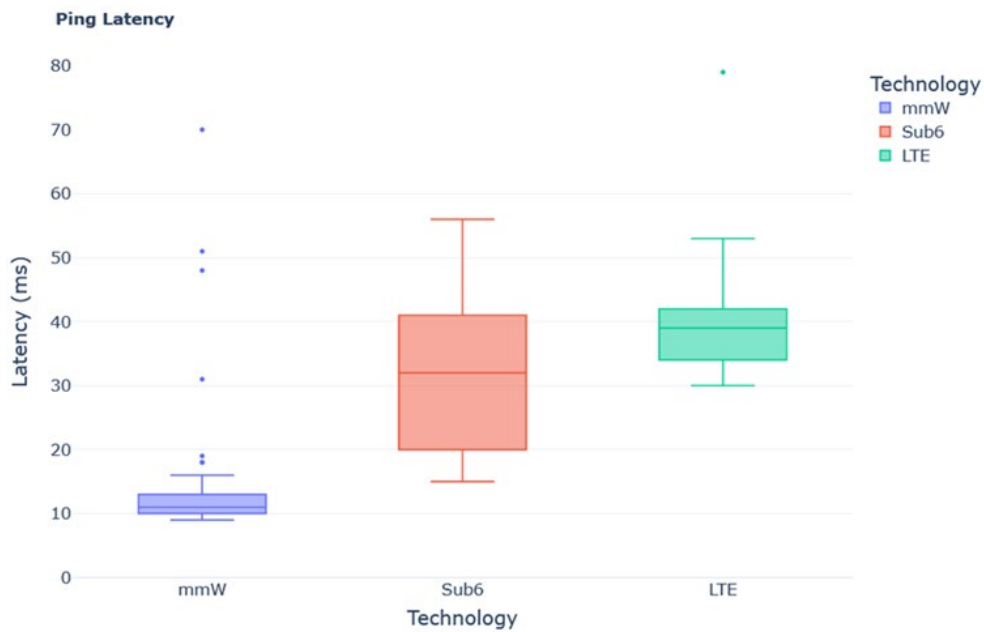

Fig. 5-9 Outdoor walking measurement of 5G mm-wave latency

In this measurement the outdoor millimeter wave coverage was also investigated. Location of each millimeter wave base station was estimated based on the coverage maps of operators, and the distance, from a base station location to a point where the throughput and latency are measured, is recorded. As a result, it was confirmed that the millimeter wave coverage is typically at least 100 - 150m and 200 - 250m in dense streets.

#### 5.4 Performance evaluation of 5G millimeter wave at event venues

In this section, the performance evaluation results of 5G millimeter wave measured in the event venue are presented. Reference signal strength (RSRP) and downlink and uplink throughput were measured at various locations at game event venues where multiple public network 5G millimeter-wave base stations were installed. As shown in Fig.5-10, the event venue is divided into 2~3 halls with an area of 112.5 m x 60 m per hall. A total of 16 5G millimeter-wave base stations were found in the venue. The position of the millimeter-wave base station and the orientation of the antenna are shown by the blue arrows in Fig. 5-10. The results of all measurement locations are shown in Fig.5-11. The measurement results of point A near the base station as a representative point, point B at the midpoint between the base stations, and point C out of the line of sight from the base station are shown below.

Points	RSRP/PCI	DL Throughput	UL Throughput
A	-74dBm/26	1.77Gbps	293Mbps
B	-94dBm/51	888Mbps	83Mbps
C	-	244Mbps	12Mbps

As shown in the results of Points A/B, good 5G millimeter wave signals arrived over a wide area in the event venue, and high throughput was measured both downlink and upstream. On the other hand, at point C, where the roof overhangs the wall and the base station is not visible, it was not possible to connect to 5G millimeter wave, and the throughput is lower than at points A/B. The average values of 5G millimeter wave during this evaluation were RSRP -85.9 dBm, downlink throughput of 1.12 Gbps, and uplink throughput of 150 Mbps (N = 26).

At the event venue, the view is often obstructed by exhibits, but it was confirmed that the millimeter-wave connection can be maintained stably, except in places where radio waves are extremely difficult to reach, such as the four corners of the venue. In recent years, Wi-Fi signals have deteriorated at event venues, so it was confirmed that 5G millimeter wave can be used to provide stable high-speed communication in the venue.

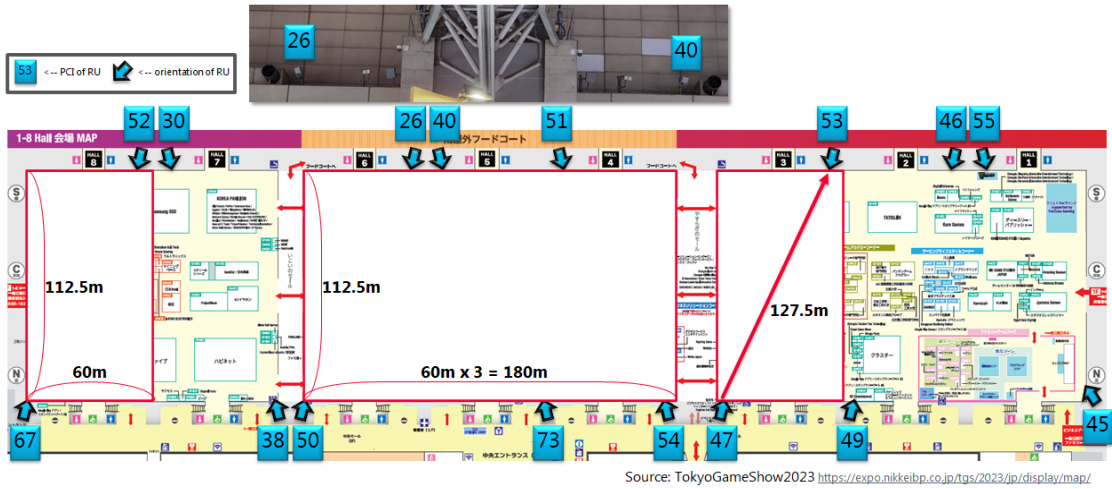

Fig. 5-10 Game Event Venues and Millimeter-Wave Base Stations

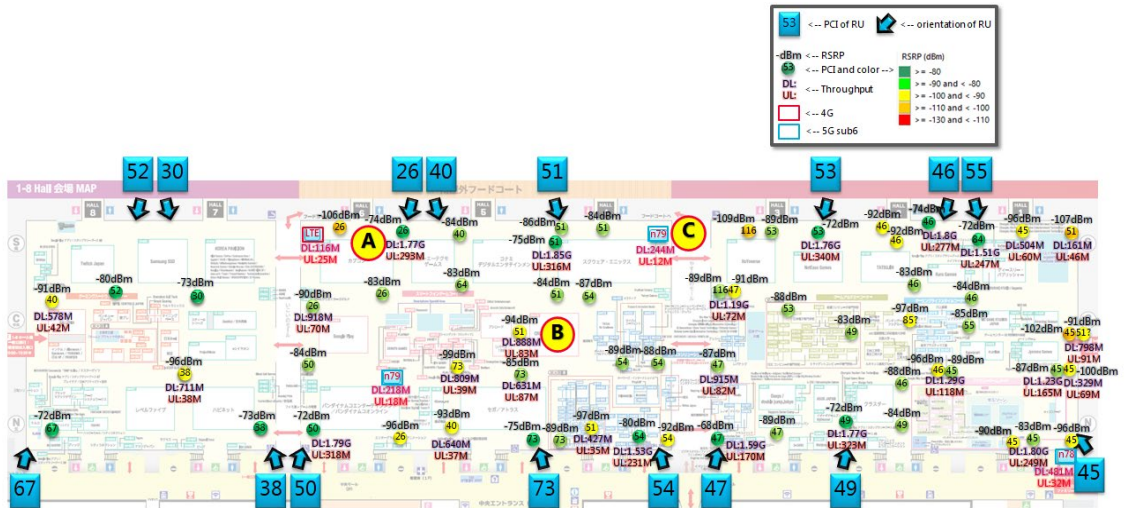

Fig. 5-11 Measurement at the gaming event venue

## 5.5 User experience evaluation of 5G millimeter wave networks

As mentioned above, 5G millimeter wave networks have excellent latency and throughput performance. However, to further promote the spread of millimeter wave networks, it is important to highlight the benefits these technical advantages bring to the daily use of general users. Therefore, this section introduces the results of evaluating the expected user experience (UX) when users use applications on these networks. In the UX test, in addition to evaluating network quality from an engineering perspective such as RSRP and S/N ratio, the response time of applications used by users is also measured.

### 5.5.1 User experience measurement of SNS in crowded spots

This time, we measured the user experience of the SNS application X (formerly Twitter), which is assumed to be used daily by many smartphone users, in crowded spots where people are densely packed. The measurements were conducted using two measurement devices based on commercially available smartphones (Keysight Nemo Handy based on Galaxy S22) and application test software (Keysight Nemo Outdoor and Application Test Automation).

The evaluation items focused on the following two communication operations mainly assumed for X, centered on downlink and uplink.

- **Feed Update** (Downlink-Centric Traffic)

In the screen where the list of posts is displayed, the action of swiping down to load the latest posts is performed. The time from swiping to when the post content is displayed on the screen is measured as the 'feed update time.' The swipe action for feed updates is automated by the application test software, which simulates touch input on the smartphone. Additionally, the time measurement until the posts are updated is automatically performed by the application test software through screen recognition.

- **Posting a Video** (Uplink-Centric Traffic)

A post with a video of about 20 seconds (approximately 10 MB) is created, and the time from touching the post button until it is reflected in the feed is recorded as the 'posting time.' The operations required for posting (video recording, attaching to the post, touching the post button) are automated by the application test software, which simulates touch input on the smartphone. Additionally, the time measurement until the video post is reflected is automatically performed by the application test software through screen recognition.

The UX measurement was conducted at the station square of a terminal station in Tokyo, where there is a high volume of pedestrian traffic, during the evening rush hour (around 19:30 to 20:30 on Thursday and Friday) in a 5G millimeter wave-enabled area. Two smartphones of the same model and carrier were prepared, with one having the 5G millimeter wave function turned ON and the other turned OFF, and the same SNS operations were performed simultaneously on both devices.

### 5.5.2 X (Twitter) Feed Update Time

The measurement results of the time taken for feed updates are shown in Fig. 5-12. On both Thursday and Friday, both Device #1 (millimeter wave OFF, green dots on the graph) and Device #2 (millimeter wave ON, red dots on the graph) took approximately 3 seconds. Most of the required time fell within the range of 2.5 to 3.5 seconds, maintaining stable service quality regardless of the presence of millimeter wave. For downlink-centric traffic like feed updates, which do not involve large data transfers such as video playback, both devices provided a good user experience.

#### Millimeter-wave NW UX measurement example 1: Twitter (X) Feed Refreshing

Measure the time to reload your Twitter (X) feed on two devices at the same time

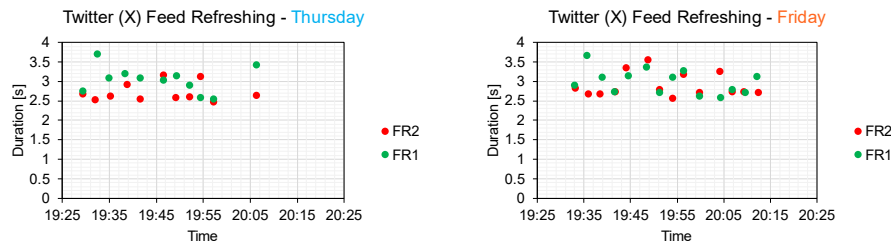

**Measurement conditions**  
 Measurement location: Tokyo Terminal Station, Station Square  
 Time Zone: Thursday & Friday 19:30 – 20:30  
 Device: 2 Nemo Handy Galaxy S22  
 MNO: Both units are the same MNO  
 Band Limitation: Device#1 turns off FR2 band

Average	Device #1 (FR1)	Device #2 (FR2)
Thursday	3.0 s	2.7 s
Friday	3.0 s	2.9 s
<b>Average</b>	<b>3.0 s</b>	<b>2.8 s</b>

Fig. 5-12 Response Time for Feed Loading on X (Provided by Keysight)

### 5.5.3 X (Twitter) Posting Time for Video Posts

Next, the measurement results of the time taken to post a video (20 seconds) are shown in Fig. 5-12. On both Thursday and Friday, the posting time for Device #2 (millimeter wave ON, red dots on the graph) was significantly shorter compared to Device #1 (millimeter wave OFF, green dots on the graph). The difference was particularly noticeable on Friday, when the station square was crowded with many people, with Device #2 completing the post in about half the time of Device #1. Additionally, Device #2 recorded stable posting times on both Thursday and Friday. These results suggest that millimeter wave networks can significantly improve UX for applications where uplink is emphasized.

#### Example 2 of UX measurement of millimeter-wave NW: Twitter (X) Video Posting

Twitter (X) measures the time to post a post with video (20 seconds) on two devices at the same time

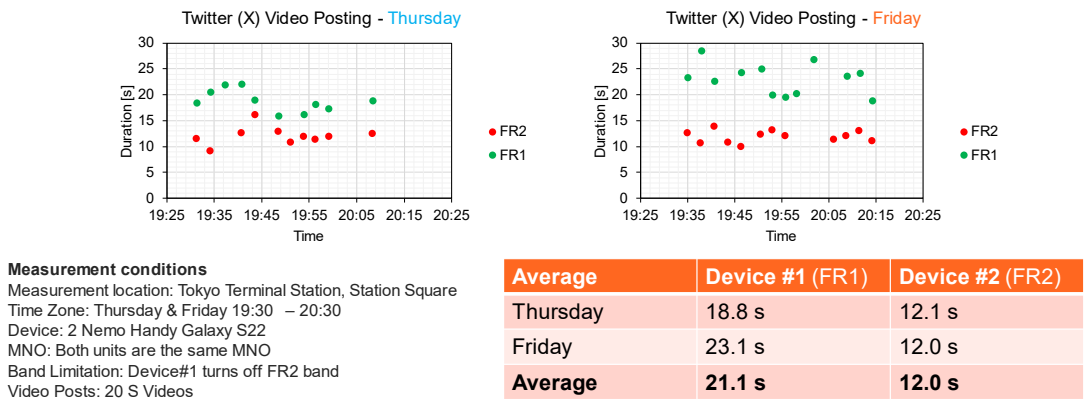

Fig. 5-13 Response Time for Posting a Video on X (Provided by Keysight)

### 5.5.4 Promoting the Benefits of 5G Millimeter Wave Networks Based on User Experience

From the user experience evaluation results using the aforementioned real applications, it is clear that the technical superiority of millimeter wave also contributes to the actual improvement of user experience. This means that the advantages of 5G millimeter wave networks are visibly apparent to general users. In recent years, many SNS applications that emphasize uplink, such as video posting, have been widely used. Therefore, the excellent user experience unique to millimeter wave serves as a good point to promote the selection of millimeter wave-compatible devices when purchasing smartphones.



## 5.6 Evaluation of Coverage Extension by Millimeter Wave Repeaters

When the introduction of millimeter wave to 5G was first considered in 2012, it was initially envisioned as a localized deployment in hotspots using small cells, rather than a broad area construction [4]. As of 2024, the deployment of millimeter wave 5G in the United States is indeed focused on hotspots such as stadiums, and it has been successful as a premium plan for business. However, in Japan, the broad deployment of 5G, including millimeter wave, is mandatory, and unlike the United States, a unique business model for millimeter wave 5G has not been established. Therefore, the key to business is how to expand the coverage of millimeter wave 5G at low cost. A technology that has recently attracted attention for expanding millimeter wave coverage at low cost is the analog repeater, which has beamforming capabilities in addition to amplification functions. This section introduces the coverage extension experiment [5] using millimeter wave repeaters conducted at the Ookayama campus of Tokyo Institute of Technology (formerly Tokyo Institute of Technology).

A private 5G environment with an NSA (Non-Stand Alone) configuration has been established within the Ookayama campus, with multiple Sub6/millimeter wave base stations deployed within the coverage of an LTE base station acting as an anchor. In the experiment introduced in this section, millimeter wave repeaters were installed at the positions of Repeater 1 and 2 shown in Fig. 5-14 [6], and the downlink throughput in the areas indicated in yellow and blue was measured using a smartphone[7]. The repeaters used in the experiment adopted a configuration where the donor unit (DU) that communicates with the base station and the service unit (SU) that communicates with the smartphone are separated. Additionally, for Repeater 2, a multi-hop architecture was introduced to wirelessly relay signals between Repeater 1 and Repeater 2. The specifications of the base stations, repeaters, and smartphones used in this experiment are shown in Table 5-2.

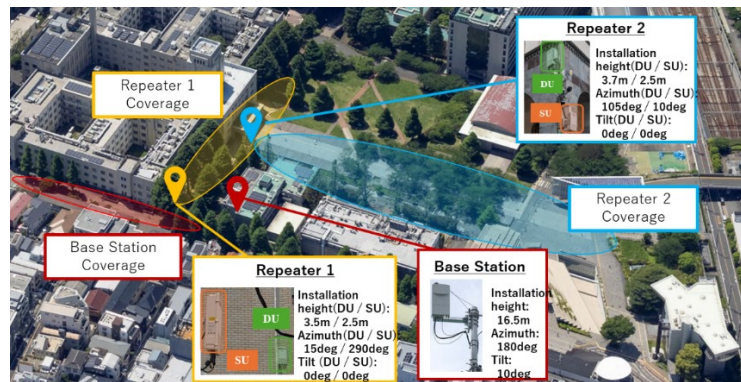

Fig. 5-14 Millimeter Wave Base Station Coverage and Repeater Deployment at Ookayama Campus

Table 5-2 Device Specifications

Base Station		Repeater		Smartphone	
Operating Frequency	n257(27.0-27.4 GHz)	Operating Frequency	27.0 – 27.4 GHz	OS	Android 10
Carrier Aggregation	4 CC × 100 MHz	Maximum EIRP	41 dBm	Chipset	Snapdragon 765G 5G
Maximum EIRP	51 dBm /400 MHz	MIMO support	2x2 MIMO	Supported Modulation Schemes	QPSK, 16QAM, 64QAM
SCS	120 kHz	System Gain	≤ 105 dB	MIMO support (DL)	2x2 MIMO

Fig. 5-15 shows the experimental results of coverage extension using millimeter wave repeaters. As shown in (a) in Fig. 5-15, without the repeater, there was almost no coverage in the east-west direction due to the straight-line propagation of millimeter wave. However, as shown in (b), by introducing one repeater and directing the SU to the west, a stable throughput of over 1 Gbps was achieved. On the other hand, in (b), due to the blocking effects of buildings and trees and the beam width of the device, coverage did not extend to the north.

Here, the advantage of introducing multiple repeaters comes into play. As shown in (c), by introducing a second repeater, an area achieving a throughput of about 1 Gbps was newly formed extending nearly 100 meters to the north. Although the wireless multi-hop with analog repeaters amplifies not only the desired signal but also noise, degrading the SINR (Signal to Interference plus Noise Ratio), a high throughput of about 1 Gbps was still achieved, demonstrating the effectiveness of repeaters in millimeter wave environments.

As shown in this section, repeaters are a useful tool for significantly expanding millimeter wave coverage as long as power and installation locations can be secured, and they are expected to become a key technology for low-cost millimeter wave area expansion.

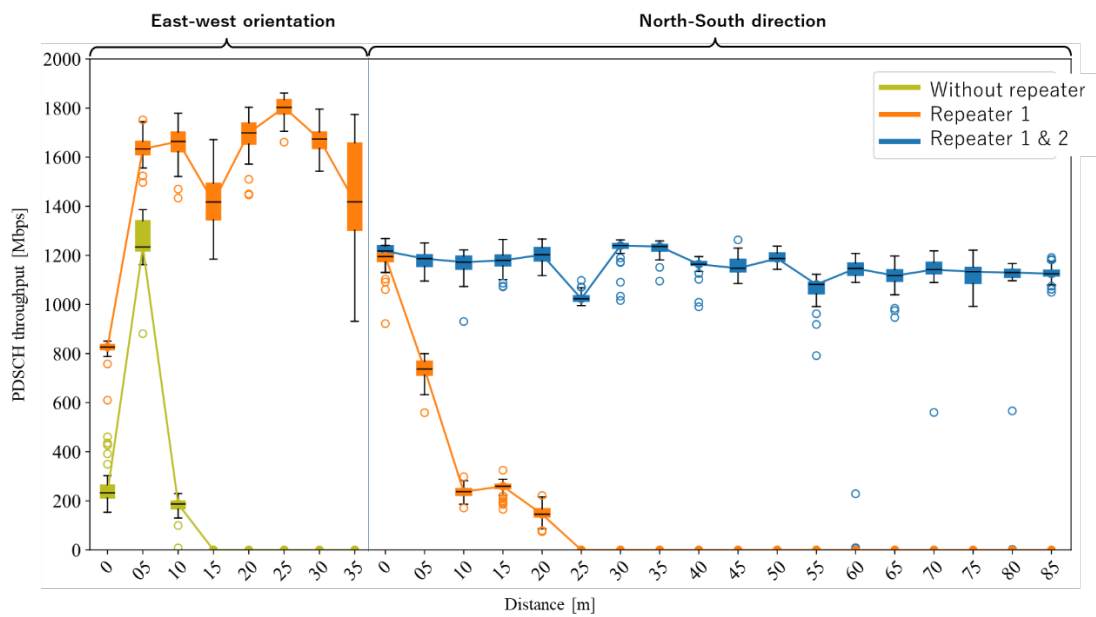
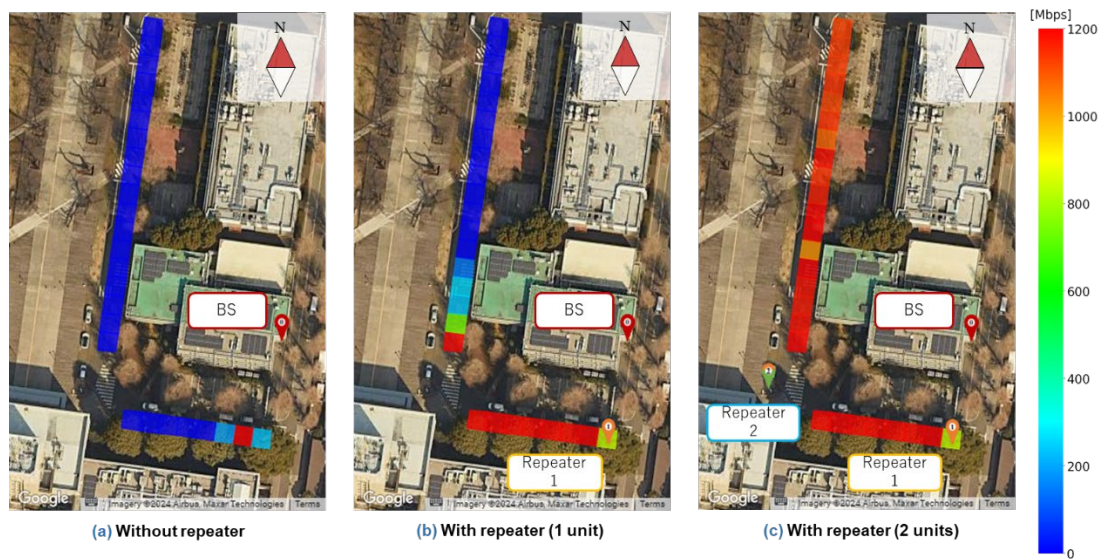

Fig. 5-15 Measurement Results of Physical Layer Throughput (PDSCH Throughput) in Downlink (The heatmap shows the median of 1-minute measurements taken every 5 meters)

## 5.7 5G millimeter wave Challenges and Solutions

Millimeter wave has similar characteristics to light and have a strong directivity. Therefore, as understood from the previous section, the issue is how to cover areas that are non-line of sight from the base station. Although it is conceivable to deploy a large number of base stations in such an area, it is not economical; more efficient techniques for establishing an area are required. Therefore, various studies have been conducted to establish new wireless network topologies using repeaters (or relay stations), reflectors, and metasurfaces. These technologies are to create new radio propagation paths, or to avoid blocking objects by high-frequency transmission lines. Such technologies are expected to extend the millimeter wave coverage to non-line of sight areas [8].

### <Repeater>

A Repeater is a wireless device that relays radio waves. By amplifying and forwarding received signals from the base station that have been weakened by attenuation /shadowing, the coverage can be extended. For example, a Repeater consists of a donor unit serving from a base station and a service unit serving to a terminal, and these are connected by a coaxial cable. An area can be constructed by installing the donor unit in the direction of the base station and the service unit in the direction in which the area is to be constructed. A beamforming antenna panel is used for donor and service units, where the horizontal and vertical beam width and beam direction can be changed electrically, so that flexible area construction is enabled as needed. It was reported in [6-7] that a repeater with an output of +37 dBm (5 W) for 4 carriers with a signal bandwidth of 100 MHz (400 MHz bandwidth in total) is developed, where the repeater has a 64-element array antenna for beamforming with the 3dB beam width of 15 to 80 degrees and the beam steering range of  $\pm 30$  degrees for both horizontal and vertical planes. [9-10]

### <Metamaterial/metasurface application>

For non-line-of-sight areas, adaptive or dynamic control of radio wave propagation paths according to the surrounding environment is being studied. One of the specific technologies for controlling radio wave propagation paths is RIS (Reconfigurable Intelligent Surface). Metamaterials and metasurfaces are the components used for RIS. These consist of a large number of elements that scatter electromagnetic waves and are designed or controlled such that the scattering characteristics are managed. Since the metasurface can be manufactured in a sheet shape, it can be installed according to the shape of the structure.

By controlling the reflected phase distribution via RIS, it is possible to control the propagation paths of the reflected radio wave, so that the received power at a target receiving location. In the transparent dynamic metasurface, a transparent glass substrate is placed on a transparent metasurface substrate, and by slightly moving the glass substrate, the mode that passes the incident radio wave, part of the radio wave is transmitted, and part of the radio wave is reflected. It can dynamically control 3 patterns: transparent mode, partial transparent mode, and mode that reflects all radio waves. In an experiment, it was observed that a transmittance of -1.4 dB or more in transmission mode and a transmittance of -10 dB or less in reflection mode [11]. In addition, the transparent metasurface lens has a film shape that can be attached to the window glass, and can focus radio waves passing through the window glass to a specific indoor location (hereinafter referred to as the focal point). Therefore, by placing a repeater or reflector at the focal point, it is possible to create an area within the building. In a demonstration experiment, it was confirmed that the received power at the focal point was improved by more than 24 dB compared to the case of using normal transmission glass [11].

#### <Dielectric waveguide application>

It is also necessary to consider the case that the radio shielding object will move. Such scenario corresponds to, for example, the layout change of the manufacturing equipment due to the change of the production line. The application of dielectric waveguides is being studied as a method of quickly and economically providing a line-of-sight communication environment against these fluctuations in the propagation environment. A dielectric waveguide is used to bypasses the transmission line for a high frequency band, so that shielding/blocking objects are avoided and can create coverage for a non-line-of-sight area. Also, radio waves are radiated from a part of the dielectric waveguide to form a communication area in the surroundings. So far, two methods of the principle of radiation of radio waves from waveguides has been studied; bending the waveguide and emitting radio waves from the bent portion and bringing the waveguide into contact with another dielectric so that the dielectric emits radio waves [12].

## References

- [1] 'Mobile mmWave Is Here – and Indoor Deployment Opportunities Abound,' Published by Fierce Wireless, presented by Qualcomm  
[https://www.qualcomm.com/content/dam/qcomm-martech/dm-assets/documents/fierce\\_ebrief\\_-\\_mobile\\_mmwave\\_is\\_here\\_-\\_and\\_indoor\\_deployment\\_opportunities\\_abound\\_smaller.pdf](https://www.qualcomm.com/content/dam/qcomm-martech/dm-assets/documents/fierce_ebrief_-_mobile_mmwave_is_here_-_and_indoor_deployment_opportunities_abound_smaller.pdf)
- [2] 5G mmWave was working well in Tokyo,' SIGNALS Research Group, June 2022.  
<https://www.qualcomm.com/content/dam/qcomm-martech/dm-assets/documents/SRG-Japan-5G-mmWave-Whitepaper.pdf>
- [3] <https://www.speedtest.net/apps>
- [4] K. Sakaguchi et al., "Millimeter-Wave Evolution for 5G Cellular Networks," *IEICE Trans. Commun.*, vol. E98-B, no. 3, pp. 388-402, Mar. 2015.
- [5] N. Okubo et al., "Field Evaluation of 5G mmWave Relays in Various Topologies: NLOS Coverage Enhancement and Tolerance against Blockage." (to be submitted to *IEEE Access*).
- [6] FRTek, "PrimAer." [Online]. Available:  
[https://www.frtek.com/jp/board/board.php?bo\\_table=wireless&cate=RF&idx=102](https://www.frtek.com/jp/board/board.php?bo_table=wireless&cate=RF&idx=102)
- [7] Rakuten Mobile, "Rakuten Mobile Releases New Original 5G Smartphone: Rakuten BIG s." [Online]. Available:
- [8] "5G Sophistication and 6G," NTT Docomo White Paper, Version 5.0,  
[https://www.docomo.ne.jp/binary/pdf/corporate/technology/whitepaper\\_6g/DOCOMO\\_6G\\_White\\_PaperJP\\_20221116.pdf](https://www.docomo.ne.jp/binary/pdf/corporate/technology/whitepaper_6g/DOCOMO_6G_White_PaperJP_20221116.pdf)
- [9] Development of 5G RF Repeater, Denko Technical Report, No. 53, 2021
- [10] <https://denkikogyo.co.jp/elec/product/mobile/15g/>
- [11] "Research on transparent RIS technology for 5G evolution & 6G," *NTT DOCOMO Technical Journal*, Vol. 29, No.3, Oct 2021.
- [12] "Pinch Antenna - Antenna Application of Dielectric Waveguide," *NTT DOCOMO Technical Journal*, Vol. 29, No.3, Oct 2021.

## 6 Millimeter wave introduction scenario

Various frequencies are currently used worldwide in mobile communications. Likewise, a wide range of frequencies from 700MHz to 28GHz is used in Japan. Since radio wave propagation characteristics and frequency bandwidths differ greatly depending on the frequency band, mobile network operators use the proper frequency band for the right place(Fig. 6-1).

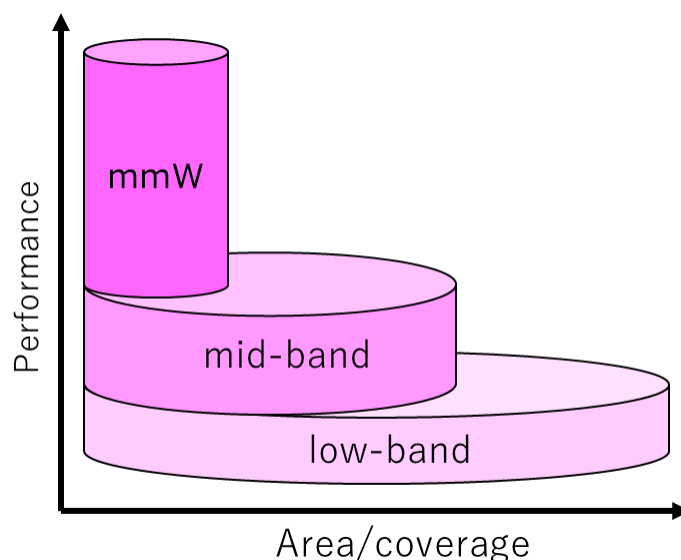

Fig. 6-1 Image of proper use of frequency bands

Specifically, low frequencies below 1 GHz have a small propagation loss but a small frequency bandwidth, so they are mainly used to cover the service area including mountainous region (coverage band). Although the higher frequency band, i.e. mid-band and millimeter wave, has a larger propagation loss, it has a wide frequency bandwidth, so it is mainly used to provide high-speed, large-capacity services in areas with heavy traffic (capacity band).

Since millimeter wave is in a particularly high frequency band, it is important to make use of their characteristics. Although the cell radius becomes relatively small due to the large propagation loss, it is effective for applications in narrow and closed areas, when it is desired to prevent radio waves from leaking outside the service area as much as possible by taking advantage of this characteristics. High-speed, large-capacity capability due to a large frequency bandwidth is effective in places where heavy traffic is generated and high-speed services are required. Based on these characteristics, the following millimeter wave introduction scenarios can be considered(Fig. 6-2).

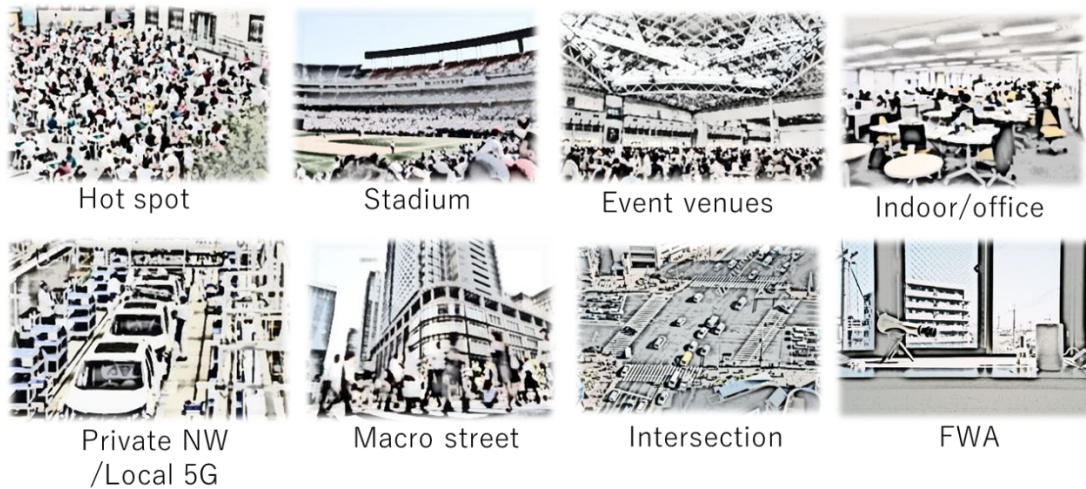

Fig. 6-2 Example of millimeter wave introduction scenarios

1) Hotspots, stadiums, event venues

It is a specific area where many people gather and requires a large communication capacity. Location-specific high-speed service is also provided. In these introduction scenarios, flexible operation of millimeter wave that adapts to surrounding traffic, environment, and behavior, including temporary installation of millimeter wave base stations, is expected.

2) Office, indoor

It is a closed space which covers a specific, relatively small area. By reflecting radio waves, it is possible to build a good communication environment even in non-line-of-sight conditions. As there is a lot of communication demand, high speed and large capacity are required.

3) Private NW/Local 5G

It is a closed premises, and it is necessary to minimize the leakage of radio waves outside the service area as much as possible. A high-speed, large-capacity communication environment is expected within the service area.

4) Urban sidewalks, roads and intersections

Due to the demand for communication by many people and vehicles, a large communication capacity is required.



## 5) FWA

There is a high need for FWA, which can easily and inexpensively create a high-speed home communication environment in a very short period of time as an alternative to optical fiber lines. Even if optical fiber is widely used, many FWA solutions are being provided in Japan.

In addition to the above, more millimeter wave introduction scenarios are conceivable. It is expected that more millimeter wave deployment will be required in accordance with the future spread of millimeter wave supporting terminals and the provision of services unique to millimeter wave.

## 7 Affinity with local 5G

### 7.1 What is local 5G?

#### 7.1.1 Regulation overview

In addition to nationwide 5G services provided by mobile phone operators, local 5G is a 5G wireless system that can be used by various entities such as local companies and municipal governments to flexibly build and use networks in their own buildings and premises. As a system, it was institutionalized in 2019. Like nationwide 5G, local 5G has the characteristics of ultra-high speed, ultra-low latency, and multiple simultaneous connections, and its technical specifications are basically the same as those of nationwide 5G.

In 2020, the frequencies were expanded, and sub6 (4.7 GHz band) and additional 28 GHz became available in addition to the initial millimeter wave (28 GHz band). In addition, "semi-synchronous TDD<sup>1</sup>" operation with a ratio of "uplink 1:downlink 1" is also possible to meet the needs of users who emphasize uplink communication such as video transmission.

Taking advantage of these characteristics, in addition to industrial use such as medical care, construction industry, agriculture, manufacturing industry, logistics, entertainment, etc., it is expected that Local 5G will be used for various needs, such as utilization related to community development, safety and security, health, welfare, tourism, education, etc. including solving the problems of regional issues.

Local 5G is basically assumed to be used for self-employed purposes. It is also possible to receive provision as a service from the viewpoint of responding to the diverse needs closely related to the region, it is also possible to request the construction and operation of networks from local business operators, etc., and use them as telecommunications services.

---

<sup>1</sup> Quasi-synchronous TDD: It is the method to simplify radio wave interference coordination for asynchronous operation, only the uplink/downlink slot patterns are partially changed while matching the slot timing with synchronous TDD for nationwide 5G and local 5G. In local 5G, a regulation was developed in December 2020 for the most popular pattern with a ratio of "1 uplink: 1 downlink" as a "TDD pattern with a high ratio of uplink slots".

### 7.1.2 Allocated frequency bands (sub6, millimeter wave)

Fig. 7-1 shows the allocated frequency bands for local 5G. In December 2019, local 5G became available in a part of the 28GHz band (28.2-28.3GHz) by establishing of a regulation related to the Radio Law. In December 2020, the frequency band (4.6-4.9GHz) and 28 GHz (28.3-29.1GHz) were also allocated.

In the sub6 band (4.6-4.9GHz), 4.6-4.8GHz (200MHz width) is a band shared with public service radio, so it is limited to indoor use, and its use is restricted in some areas.

Since the millimeter wave band (28.2-29.1GHz) is a band shared with the Ka-band satellite communication system, indoor use is recommended especially for the 28.45-29.1GHz (650MHz width). (Because of the possibility of being affected by satellites, it is basically used indoors, but outdoor use is also possible.)

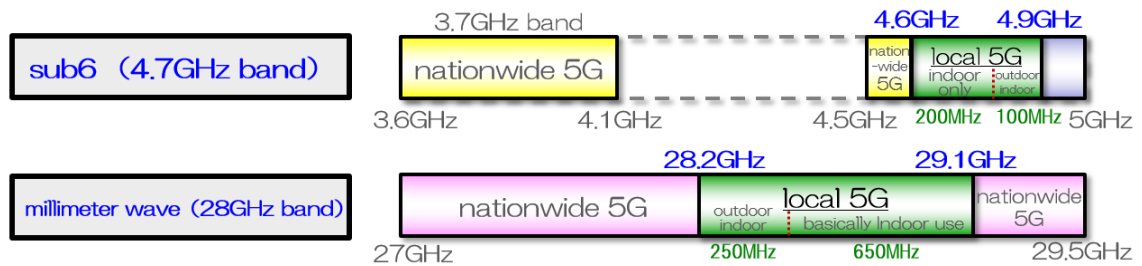

Fig.7-1 Local 5G allocated frequency band

## 7.2 Current state of local 5G

### 7.2.1 Overview (past history to popularization)

Local 5G was firstly developed in December 2019, so the first commercial local 5G license was granted at about the same time as the nationwide 5G service of mobile network operators was launched in March 2020.

First, the NSA system which an anchor band using BWA private operation<sup>2</sup> is used with combination of the 100MHz width of the millimeter wave band for indoor and outdoor. After 1 year later, from December 2020, the sub6 band which can be used for outdoor operation and millimeter wave band became available. Since then, the SA system, which does not require an LTE anchor band, has been introduced with a 100MHz width of 4.8-4.9GHz.

Fig. 7-2 shows the trend in the number of local 5G licenses. Since December 2020, the introduction of sub6 base stations has increased rapidly, but the number of millimeter wave base stations has remained unchanged.

On the other hand, the Ministry of Internal Affairs and Communications is aiming to promote the dissemination of local 5G, which has just been regulated. In the three years from FY2020 to FY2022, we have been conducting technical studies such as transmission, and “development demonstrations for the realization of problem-solving local 5G, etc.” to create utilization solutions including use cases. Figure 7-3 shows the transition of local 5G development demonstration. It can be seen that the demonstration experiments using sub6 accounted for the majority even in the last three years.

In addition, the Ministry of Internal Affairs and Communications established a 5G investment promotion tax system in August 2020 to promote investment in local 5G, and has been working to further spread local 5G.

As a result of these various measures and corporate activities, as of the end of August 2024, 154 sub6 operators and 26 millimeter wave operators have obtained local 5G licenses. However, after about three years, the progress has been limited to a certain extent.

---

<sup>2</sup> BWA private operation: A system for wireless systems that uses the same frequency band (2575-2595MHz) as regional BWAs and can be developed and operated using the 4G/LTE system within their own premises or buildings in the same manner as local 5G. It was regulated in December 2019 in line with local 5G. In the summer of 2020, the system for 5G-BWA (NR) was developed.

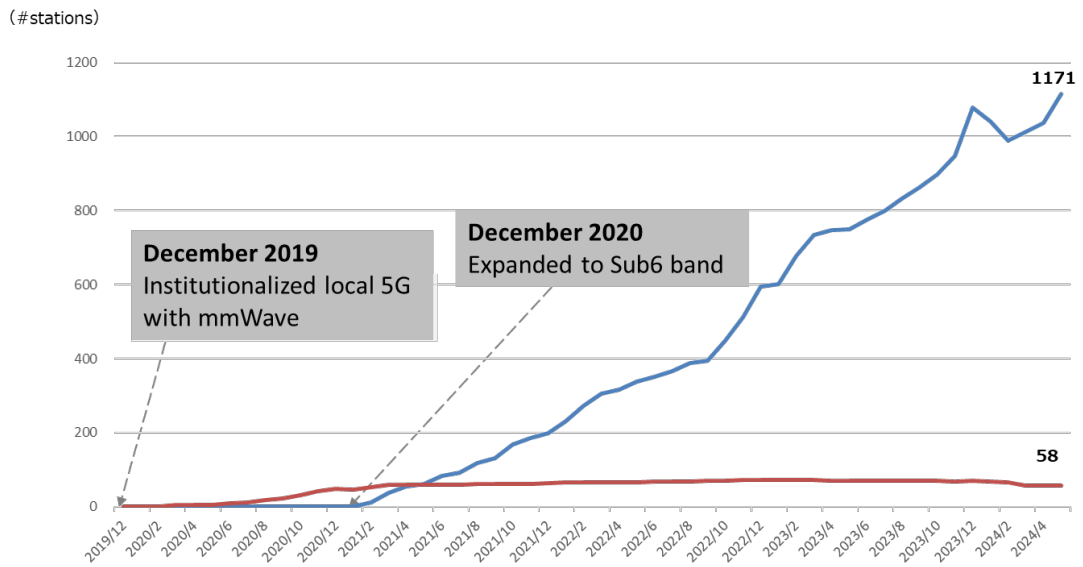

Fig.7-2 Changes in the number of local 5G licenses [1]

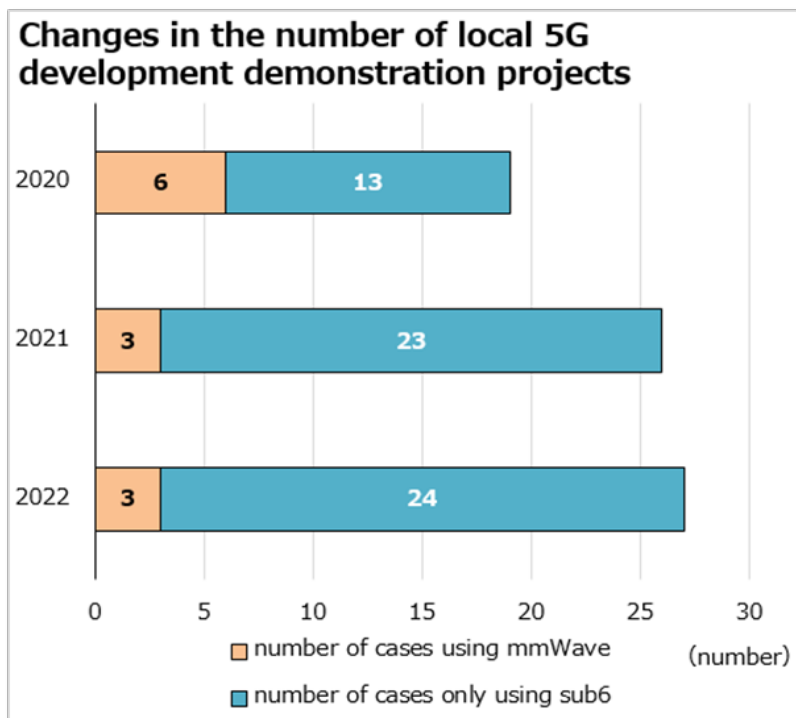

Fig.7-3 Changes in the number of local 5G development demonstrations [1]

## 7.2.2 Situation for millimeter wave (actual situation)

As we are discussing so far, three years have passed since the first system was established, and although local 5G has spread to a certain extent, the number of deployments is still not sufficient, and most are concentrated on sub6. The current situation is that the demand for millimeter wave is sluggish.

There are many factors that can affect 5G infrastructure, including low-band, mid-band, and sub6 infrastructure development in countries around the world, and the lack of millimeter wave development by domestic mobile network operators. Hereafter, we have sorted out the “factors that hinder the spread of millimeter wave” that can be considered as unique issues to local 5G.

### **【 Difficult to build an area 】**

It has a strong directivity and is difficult to propagate far away due to the influence of obstructions, etc., it is difficult to construct an area (cell planning) within a building or site. For example, in the case of an outdoor station, although the coverage area can be expanded along the path (line of sight) between buildings, it becomes difficult to establish an area even at a distance of several tens of meters from the base station when in the shade of a building. Also, with indoor stations, it is difficult to create an area for multiple floors with a single base station, and even on a single floor, it is difficult to create an area for multiple rooms, excluding rooms near the base station, when creating an area along a corridor.

### **【 The NSA method was the mainstream, complicated, and expensive 】**

While the SA system is currently the mainstream for sub6 wireless equipment, the NSA system was the mainstream for millimeter wave, so the system configuration was complicated, and in addition to the relatively expensive local 5G equipment, the cost of 4G equipment was also high. (In the future, it is expected that NRDC, which mobile network carriers are beginning to implement, will also be applied to local 5G).

In addition, 4G that is used as an anchor band in the NSA system includes 1.9 GHz band TD-LTE (sXGP), private operation BWA, regional BWA, nationwide BWA, and nationwide 4G. However, the NSA operation with private operation BWA is difficult for outdoor use, especially in urban areas, due to the problem of interference with regional BWAs that use the same frequency band.

**【 There are few millimeter wave supporting terminals, and the cost is high 】**

There are few 5G terminals (industrial routers, etc.) that support millimeter wave, and the price is high. As a result, it is mostly used as a repeater that converts to Wi-Fi, and as a result, cases where the need for local 5G are diminished. Table 7-1 shows the status of local 5G compatible terminals.

Table 7-1 Status of local 5G compatible terminals (according to March 2023 survey)

Manufacture name.	type	terminal type	Corresponding frequency	
			millimeter wave	sub6
Compal	Raku Plus	Mobile router	○	○
	5G dongle Tributo	USB dongle	—	○
Kyosera	K5G-C-100A	Mobile router	○	○
FCNT	FMP181L	Smartphone	○	○
	SD01	Smartphone	—	○
	BZ03	Smartphone	—	○
NEC Magnus Communications	FG900CS	Mobile router	—	○
Nokia	FastMile 5G Gateway 3.2	Mobile router	—	○
Fujisoft	+F FS050W	Mobile router	—	○
NETGEAR	MR6550-100APS	Mobile router	○	○
SONY	PDT-FP1	Radio Communication Device	○	○
SONY	XQ-CT44	Smartphone	—	○
SONY	XQ-DQ44	Smartphone	—	○
SONY	XQ-EC44	Smartphone	—	○

**【 After the sub6 regulation establishment, there is a feeling that millimeter wave deployment will be postponed 】**

Since December 2020, when the regulation for the sub6 band was established, development manufacturers and vendors have shifted to commercializing sub6, which is easier to design areas than millimeter wave, and has a simple SA system configuration and is relatively easy to develop. Therefore, the priority of millimeter wave support has been lowered.

【 Unable to reach a use case that makes use of the ultra-wide band of millimeter wave, and it is difficult to connect it to business 】

There is also a situation where people are leaning toward the use of sub6, and the actual situation is that design considerations are being conducted within the scope of sub6 performance, without even coming up with the idea of making use of millimeter wave.

As mentioned above, there may be factors preventing the dissemination of local 5G millimeter wave. On the other hand, for example, sub6, which can be used outdoors, has a maximum width of 100MHz, so many IoT devices that handle video such as 4K cameras are being introduced. In that case, millimeter wave, which can secure a 400MHz bandwidth, will definitely be more advantageous in terms of capacity and operation of a single base station, but this is also an easy-to-overlook point.

Also, assuming the area that mobile network operators can support, there is an opinion that it may be possible to share base station facilities from the perspective of suppressing construction costs and promoting local 5G introduction smoothly. . Sharing of facilities means that local 5G millimeter band radio waves are also emitted from the 5G base station of nationwide operators. For example, in regional BWA, the sharing of base station facilities (borrowing of nationwide BWA base station facilities) is a common technique in regional BWA area development.

Based on this perspective, as local 5G, which plays a role in the dissemination of 5G in Japan, we believe that it is necessary to continue to provide and disseminate information so that all parties concerned can correctly understand the characteristics of millimeter wave as compared with sub6 and how to use it.



### **7.3 Affinity between millimeter wave and local 5G**

The basic of local 5G utilization is the ability to create spots within one's own building or premises, and flexibly operate them independently according to diverse needs. Since it is assumed that many terminals will be used intensively at the same time in a relatively small area, it can be said that millimeter wave, which can handle ultra-wideband, have a very high affinity with local 5G, including the characteristics of radio waves.

Three points regarding affinity will be shown below.

#### **7.3.1 Area scale and radio wave characteristics (good compatibility with millimeter wave coverage area)**

It can be said that local 5G, which is used in a limited area, is compatible with millimeter wave coverage areas.

According to a general interpretation, millimeter wave is weak against shields due to directivity, and easily affected by rain and snow. In terms of propagation distance, a distance of about 100 to 200m is realistic in an environment with non-line of sight, such as in a city, and certainly it cannot be said it propagates well.

On the other hand, when we look at the actual use of local 5G, as shown in Fig.7-4, it is often used in relatively narrow areas. For example, if it is used inside a building (indoor), it is desirable to suppress the leakage of radio waves to the outside, so it is convenient for millimeter wave that is weak to shielding. Even when using local 5G on the premises of a business such as a factory, it can be said that millimeter wave is easier to control than sub6 in order to suppress the leakage of radio waves outside the premises. In addition, millimeter wave is also suitable for "urban development" initiatives such as super cities and smart cities, where you want to set up a safe and secure communication spot in a limited area using smart poles, for example.

With local 5G, everyone can set up their own 5G at their own place, but it is necessary to take care that leaked radio waves between neighbors do not cause interference with each other. Sub6 has a longer propagation distance than millimeter wave, but instead, the amount of radio waves that leak out is also greater. Millimeter wave, which has a shorter propagation distance than sub6, can be said to be particularly convenient for handling in densely populated areas.



Fig.7-4 Image of local 5G, which is expected to be used in various places such as “in the city” [2]

### 7.3.2 Communication capacity and communication demand (good compatibility with high speed and large capacity)

Local 5G, which is used in a limited area, can be used by a large number of terminals in a relatively small space, so it can be said that it is suitable for millimeter wave, which can easily secure large capacity.

In the millimeter wave band of local 5G, a 900MHz bandwidth is reserved for allocation, and it is possible to operate 400MHz bandwidth like national 5G. Broadband operation is also technically possible.

For example, as shown in Fig. 7-5, when performing real-time video surveillance using a 4K camera, assuming a transmission rate of about 20 to 25 Mbps for the uplink with one camera, the operation of 10 cameras will exceed 200 Mbps. It makes difficult to use other 5G equipment as the 100 MHz bandwidth of sub6 (64 QAM, 2 × 2 MIMO, synchronous operation) will almost reach the uplink communication capacity., .

On the other hand, if the millimeter wave bandwidth is 400 MHz (64 QAM, 2 x 2 MIMO, synchronous operation), a communication capacity of about 800 Mbps can be secured in the uplink, so a 4K camera can be added, or a large number of other 5G devices can be mixed. When it comes to 5G, people tend to focus on the download speed of smartphones, etc., but local 5G, which is expected to operate with an emphasis on uplinks that constantly transmit data in real time, such as monitoring the status of facilities and collecting data, is not limited to downlinks. Uplink communication capacity is also an important point.

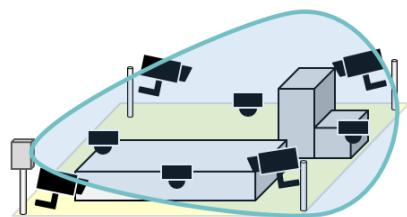

factory/office use(inside the facility)

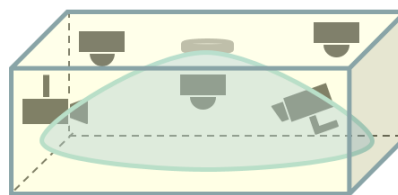

indoor use(store/building floor etc.)

Fig.7-5 Image of video surveillance with a 4K camera on local 5G

In actual camera operation, the required number of cameras will be determined by adjusting the image quality, angle of view, frame rate, transmission rate, compression method, etc. of the camera considering the transmission capacity that can be achieved by the sub6 5G base station equipment. Advance consideration and design are assumed. But with millimeter wave, it will be possible to determine the number with flexibility to such ingenuity.

In local 5G, "semi-synchronous TDD operation" has been regulated for operations that emphasize such uplink communication, and in millimeter wave, uplink capacity is doubled with (uplink 1 : downlink 1 ratio) as compared with synchronous operation (uplink 1: downlink 3 ratio).<sup>3</sup>

Local 5G also requires a correct understanding of the usage conditions in the millimeter wave frequency band (28.2-29.1 GHz). As mentioned above, since the mm-wave band is shared with the Ka-band satellite communication system, it is restricted to install the antennas of local 5G base stations above the horizon. The 250MHz band of 28.2 to 28.45GHz can be used both indoors and outdoors, but the 650MHz band of 28.45 to 29.1GHz is recommended for indoor use. This is because local 5G base stations can be affected by earth stations (base stations on the ground) that communicate with satellites. It does not mean local 5G interferes to the satellite systems.

---

<sup>3</sup> In semi-synchronous TDD operation, although the uplink capacity is increased, the downlink capacity is smaller than that of synchronous operation, so it may not be suitable for downlink-oriented use case. Also, if there are local 5G licensees using the same frequency for synchronous operation in the vicinity, such as adjacent, there is a possibility that communication failure will occur due to interference. Semi-synchronous TDD operation must protect the synchronous operation from communication failure, so when using semi-synchronous TDD operation outdoors, it is necessary to pay attention to the impact on other local 5G systems.

However, although outdoor use is optional since the presence and degree of influence will change depending on the operating conditions of the earth station (location, height, antenna direction, etc.), understanding and caution are required.<sup>4</sup>

In this way, millimeter wave local 5G, which is capable of ultra-wideband operation, is not just about fast communication speeds, it is also easy to handle 5G terminals that require high transmission rates. Since it is easy to handle a wide variety of simultaneous connections, it is important to effectively adopt the proper use and combination of millimeter wave and sub6 according to the required communication capacity and speed in the local 5G area. It is thought that it will be a point to promote the utilization of millimeter wave.

### **7.3.3 Compact system scale (good compatibility with system scale and ultra-low latency)**

In local 5G, which is used in a limited area, it is easy to integrate the entire system into a relatively compact size, so it is easy to realize the ultra-low latency that is a feature of 5G, and it can be said that it is suitable for millimeter wave.

The local 5G system, like the national 5G system, consists of 5G core equipment and base station equipment (RAN). Since the NSA system was the main component for millimeter wave, the anchor band 4G equipment will also be developed. But as shown in Fig. 7-6, it is assumed that the company will build its own equipment, including the core equipment. If so, the facility is considered to be installed within the local 5G service area. With such a configuration, not only the radio section between the 5G base station and the terminal, but also the physical proximity between the RAN equipment and the 5G core equipment will be physically close, enabling data processing within the local 5G area. It becomes easy to realize low delay.

Also, in the near future, it is possible that the anchor band will be converted to 5G, so it is expected that sub6 will play a role in local 5G. Regarding the 5G core, two options can be considered, one is to build it yourself and the other is to use the cloud core.

---

<sup>4</sup> The joint study of earth station and local 5G is based on the result of studying the impact on the local 5G base station in the most severe case for the earth station type with the highest transmission power. In addition, according to the radio wave usage survey conducted by the Ministry of Internal Affairs and Communications (as of June 2020), the "There are 38 radio stations (20 fixed installation type, 18 portable type) of "Earth station". It is operated irregularly from time to time. In addition, the case where the "earth station" is installed with an antenna height of 50m, which is particularly susceptible to interference, is currently limited to one location in Tokyo, and the range of interference is limited. However, it is necessary to consider the possibility of future station placement. [3]

In either case, ultra-low latency can be expected if data processing can be performed within the local 5G area.

If the scale of the entire system is within the local 5G area, security measures will be easier. For example, safe operation can be easily achieved without connection to an external network such as the Internet, but if you want to use it together with an Internet connection, only a specific network (a group of terminals) will be blocked from connecting to the outside. By setting a "closed network", it is possible to flexibly obtain a safe environment as needed.

A compact system scale is likely to work favorably for the adoption and introduction of Open RAN. As a general assumption, it is possible to efficiently combine RAN equipment from multiple vendors that comply with the Open RAN specifications, but in terms of equipment operation management, it is necessary to manage equipment for each vendor. In the case of local 5G, which is expected to have a small system configuration, it is possible to configure the entire system with Open RAN equipment from a single vendor.

These merits and affinities related to system scale are not limited to millimeter wave, but apply equally to sub6. If amended, the NSA for millimeter wave shown in Fig. 7-6 can shift to the SA if we look further into the future. DC (dual carrier) is also possible by combining millimeter wave and sub6 to achieve stability during millimeter wave connections and further increase in capacity and speed. In local 5G DC, it is possible to use millimeter wave to strengthen and reinforce part of the sub6 area, but from a different perspective, ultra-wideband millimeter wave is the main, and sub6 connects the gaps. By doing so, we can also think of ensuring the convenience and stability of connections in the millimeter wave area.

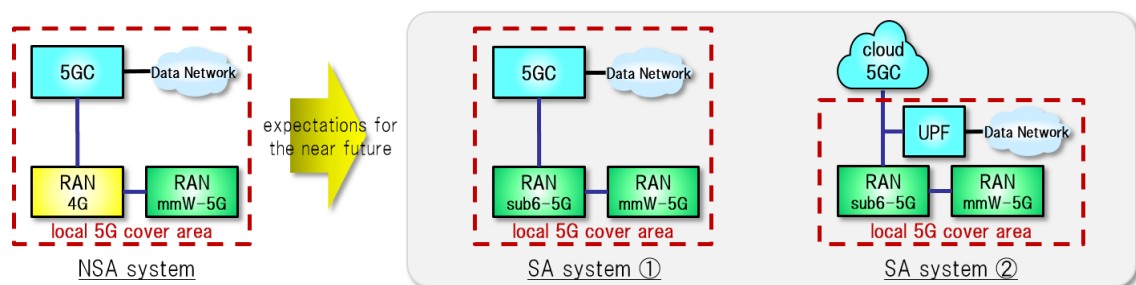

Fig. 7-6 System configuration example for local 5G millimeter wave

Three years have passed since the start of the local 5G system, and although it can be said that the introduction has progressed to a certain extent, the reality is that it has not yet been widely deployed. According to the 5G-SDC (5G utilization type social design promotion consortium) survey "Local 5G market research report (January 17, 2023)", the full-scale diffusion period is expected after 2025. [4]

Sub6 is expected to continue to be introduced for the time being, but the bandwidth that can be used outdoors is limited to 100MHz. Shortages can easily be imagined.

Aiming for a future in which the 900MHz bandwidth allocated to millimeter wave is effectively used in various social activities toward the full-scale spread of local 5G. , It is necessary for the industry as a whole to prepare early so that it makes easier to introduce millimeter wave.

## References

- [1] Ministry of Internal Affairs and Communications, Radio Policy Roundtable in the Age of Digital Transformation, 5G Business Design Working Group (1st Meeting) handout (January 24, 2023), Periodic update based on Ministry of Internal Affairs and Communications, Mobile Communications Division  
[https://www.soumu.go.jp/main\\_content/000857640.pdf](https://www.soumu.go.jp/main_content/000857640.pdf)
- [2] Ministry of Internal Affairs and Communications, Information and Communications Council New Generation Mobile Communication System Committee (12th Committee Report (Draft) Materials (Local 5G Related) Partially Used (April 12, 2019)  
[https://www.soumu.go.jp/main\\_content/000614449.pdf](https://www.soumu.go.jp/main_content/000614449.pdf)
- [3] Ministry of Internal Affairs and Communications, Information and Communications Council, New Generation Mobile Communication System Committee (18th Meeting) Committee Report (Draft) Materials (Local 5G Related) (July 6, 2020)  
[https://www.soumu.go.jp/main\\_content/000697370.pdf](https://www.soumu.go.jp/main_content/000697370.pdf)
- [4] 5G utilization type society design promotion consortium (abbreviation: 5G-SDC), from local 5G related market research report (January 17, 2023)  
<https://5g-sdc.jp/>

## 8 Millimeter wave use case

In the GSMA report, the main use cases for millimeter wave are three categories: "high-capacity high-speed transmission (eMBB) in facilities such as stadiums where people gather", "FTTH replacement by FWA", and "Enterprise Networks". This chapter describes use cases and those are divided into three categories.

As described in "Chapter 3 Issues in popularization of millimeter wave", many current use cases are satisfied with the performance of sub6. We think that those use cases would require higher performance with larger capacity and lower delay in the future.

In addition to the cases described here, from the perspective of maximizing the advantages of 5G in the future, it is expected to create a total use case that combines not only the use of millimeter wave, but also various elements such as SA, network slicing, MEC, AI, XR, Metaverse, etc.. At that time, it is also expected to utilize external resources, including open innovation and M&A of startups.

### 8.1 eMBB

The use of millimeter wave in areas where people gather, such as sports stadiums, concert venues, and airports, is expected to provide new value for applications that require high-speed, large-capacity communications, and to supplement low-band and mid-band capacity. ¥ Examples of millimeter wave use cases for eMBB are described below.

#### 8.1.1 Entertainment

- **NFL Finals Exclusive Experience [1][2]**

Deploying 169 small cells, 4 macro cells, and 24 indoor systems in the stadium and its surrounding area, it provides an entertainment experience utilizing C-band and millimeter wave. It provides live and replay video that support up to seven camera angles, player statistics using AR, and simultaneous experience-type AR games between local fans using SNS applications.



Fig 8-1 5G millimeter wave small cell installed under the seat of the stadium



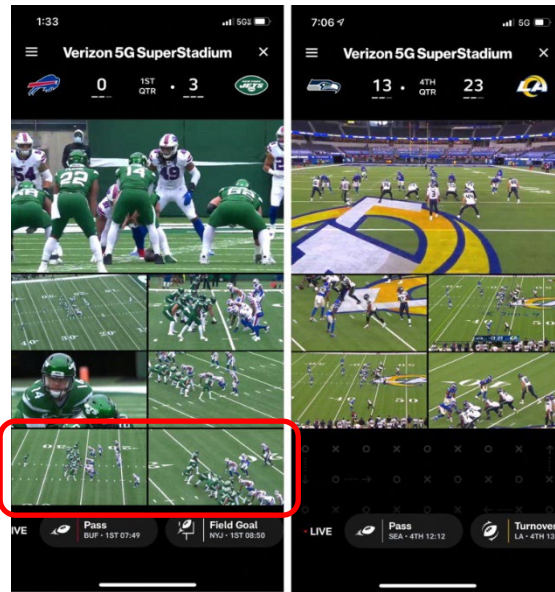

Fig 8-2 Live video replay video  
 (5G Ultra Wideband users have more streams to watch)

- **New watching experience in soccer [3]**

"5G experience seats" will be installed in the main stand of "Toyota Stadium", utilizing sub6 and millimeter wave, support information such as the number of shots and passes of each player will be displayed in the AR space through smart glasses and 5G compatible smartphones installed in each seat. By doing so, we provide new experience value to the audience.



Fig 8-3 Smart glasses and experience image

- **Exclusive experience at the theater [4]**

Installed 32 millimeter wave small cells on the premises of Taiwan's NTCH (National Concert Hall) to build a private 5G coverage of 14,000 square meters. High-definition live streaming distribution shot from multiple angles and locations, live video relay to a large 4K display installed outdoors, metaverse that reproduces the production of the performance, immersive/interactive where the audience can interact with the on-site and online. /Provide a multi-view theater experience.

- **Individually optimized signage for AR glasses [5]**

When users wearing AR glasses walk around town, individually optimized advertisements are displayed on the glasses through image recognition and marker recognition. The user's hobby and taste information registered in the cloud is matched with the content that the store wants to promote, and the corresponding video is displayed. Those encourage shop guidance by timely promoting products and gourmet that users want. Since it requires high-speed, large-capacity communication, it is expected to be used in millimeter wave in the future.

- **New information dissemination medium [6]**

Opened the Metaverse homepage to deliver service information. Visiting users can operate their own avatars to check service information and the latest news. There is also a permanent event space dedicated to holding various events such as music and comedy. In the event space, multiple users can enjoy live streaming of live music and other events at the same time, enabling live experiences with a sense of presence anytime, anywhere. Since it requires high-speed, large-capacity communication, it is expected to be used in millimeter wave in the future.



Fig 8-4 Image of Metaverse homepage

- **Improving Communication Speeds in Stadiums [7]**

All six 5G sub6 base stations installed in the spectator area of Hanshin Koshien Stadium have been replaced with MMU (Massive MIMO Units)-compatible equipment. MMU utilizes beamforming technology with numerous antenna elements to efficiently deliver radio waves to the locations where customers are using them, and it also employs Multi-User MIMO to accommodate high-density communication by serving multiple customers simultaneously.

To maximize MMU performance, the antenna layout was revamped to consider multipath within the stadium, and management technology was applied to optimize the use of wireless resources between base stations to avoid interference, which becomes an issue in environments with high communication traffic, such as densely packed stadiums. As a result, the frequency utilization efficiency of sub6 was significantly improved even during congestion, leading to a 1.6-fold increase in communication speed compared to conventional 5G communication, enabling comfortable communication services with low latency (communication response time).

Additionally, Hanshin Koshien Stadium is equipped with 5G millimeter wave (28 GHz band) base stations in addition to sub6. The use of millimeter wave is expected to be beneficial for high-speed, high-capacity communication in the future.

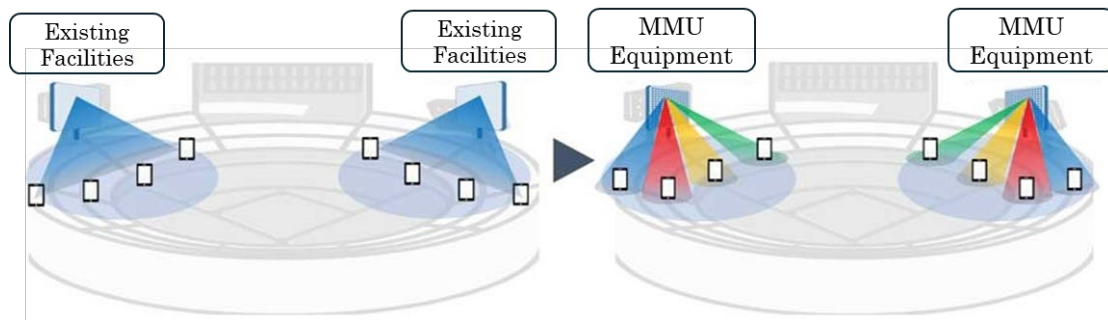

Fig. 8-5 Features/Images of MMU

## 8.2 FWA

Economic and rapid deployment is expected by utilizing 5G FWA as an alternative to FTTH in areas where FTTH is limited. Examples of millimeter wave use cases for FWA are described below.

- **Provision of FWA in urban areas [8]**

Utilizing 3.7GHz, 28GHz, and 39GHz 5G networks that are deployed for mobile use in urban areas, we provide FWA services as an alternative option to FTTH. Efficient services are provided by utilizing networks already in place for mobile devices.

- **Provision of FWA in rural areas [9]**

We provide FWA using 28GHz and 39GHz to eliminate the digital divide in rural areas. It provides a communication speed of 300 Mbps (up to 1 Gbps is possible, but considers the effects of trees and weather), and is estimated to be 40% cheaper than FTTH.

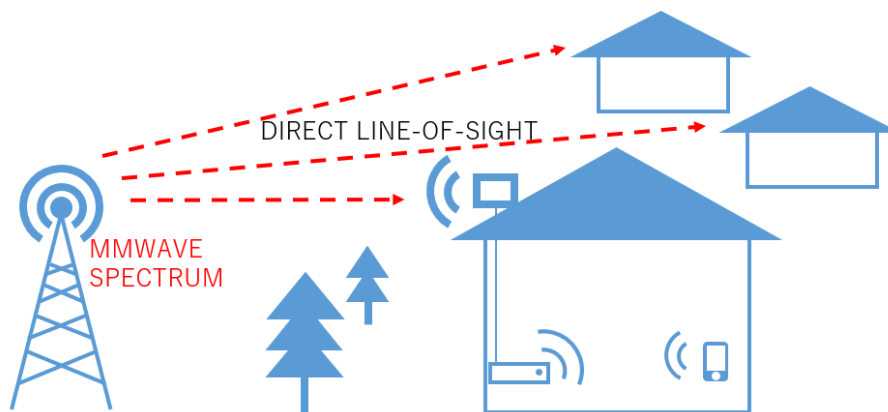

Fig 8-5 Image of provision of FWA

## 8.3 Enterprise networks

Use cases with large numbers of simultaneous accesses and high UL traffic are assumed in corporate buildings and manufacturing plants. The use of millimeter wave in such places is expected to enable the simultaneous connection of many devices and the increase in UL capacity. In addition, by taking advantage of the attenuation caused by shielding, which is a characteristics of millimeter wave, and using millimeter wave, it is expected to operate closed networks with high confidentiality. Examples of millimeter wave use cases for Enterprise Networks are described below.

### 8.3.1 Manufacturing industry

- **Sharing machine failure points from a remote location [10]**

When performing machine maintenance work, inexperienced maintenance personnel could not make correct decisions based on manuals alone, and had to ask for instructions from experts over the phone, delaying the recovery of the user's machine. Real-time sharing of information on failure points from remote locations through smart glasses has produced significant effects, such as improving the quality of maintenance work and speeding up the recovery of production at user companies. Since it requires high-speed, large-capacity communication, it is expected to be used in millimeter wave in the future



Fig 8-6 Image of remote work support

- **Quality control in flash memory manufacturing factories [11]**

Deploying 5G millimeter wave solutions with local edge cores in semiconductor fabs. With high bandwidth up to 2Gbps and ultra-low latency, applications for image-based quality control such as operation and maintenance using high-resolution immersive AR/VR glasses and automated visual inspection of chips were demonstrated.

- **Stable operation and smart factory using 4K video [12]**

By installing a high-definition ITV camera and a 5G base station to monitor the production line in the factory and transmitting 4K video shot by the camera via 5G, the accumulated video and various trends can be synchronized and analyzed. construction. The video can be checked in real time on a 4K compatible monitor in the control room. In the future, we aim to make various quality judgments by AI based on video and various trends.

### 8.3.2 Automobiles

- **Application to autonomous driving [13]**

A sub6 and millimeter wave 5G environment will be set up on test roads for research and development of autonomous driving, etc., and by using images and surrounding information acquired from high-definition in-vehicle cameras and roadside sensors, the vehicle and its surroundings will be understood more efficiently. We verified such a system. In the future, it is expected to be used in fields such as autonomous driving where it is necessary to communicate a wide variety of data according to priority.

### 8.3.3 Medical care

- **Introduction to medical research facilities [14]**

By introducing millimeter wave and MEC, real-time data analysis supports decision-making, secures dedicated bandwidth to transfer huge data files such as 3D tumor images, and realizes stable communication with many IoT devices and sensors.

- **Transmission of high-definition images between hospitals [15]**

1. Using the highly secure closed network of MEC, it is possible to transmit data from medical equipment and high-definition video from cameras to hospitals in remote locations via high-speed, large-capacity 5G communication. By utilizing the 5G telemedicine support system, for example, it will be possible to reduce the travel time of both specialist doctors and patients who had to go to remote areas for medical treatment, and to receive the same medical care in each region as in urban areas. Since it requires high-speed, large-capacity communication, it is expected to be used in millimeter wave in the future.

- **Robot replaces sterilization work [16]**

A robot equipped with a germicidal lamp replaces the first action of disinfection work for infectious disease control, which was under pressure on human resources, reduces the physical and mental burden on medical workers.

In addition, the introduction of robots makes it possible to sterilize the hospital at a more appropriate timing, providing an efficient and less risky medical environment.



Fig 8-7 Image of sterilization work by robot

#### 8.3.4 Media

- **Broadcasting of news and sports by portable high-quality video transmission equipment [17]**

It would be possible putting the video transmission device and battery in my rucksack, carrying the camera on shoulder and filmed. The video transmission equipment enables high-quality video transmission by inserting multiple multi-carrier SIMs, catching optimal millimeter wave, and bulk transmitting.

- **Total Solution for 5G Live Production [18][19]**

Sony provides a solution that uses the remote production unit CBK-RPU7 and the media edge processor NXL-ME80 to wirelessly transmit high-quality, ultra-low latency video data directly from the shooting location via 5G communication, including millimeter wave. By wireless transmission of video from the camera, the freedom of shooting positions and angles is improved, enabling more flexible live broadcasts.

Additionally, Sony plans to support the reception of return video and tally signals from remote studios via the 5G network, as well as camera control from the remote control panel (RCP), thereby realizing remote live operations.

\*1 As of December 3, 2024, the 5G devices supported are 'PDT-FP1,' 'Xperia PRO,' and 'Xperia 1 V.'

\*2 As of December 3, 2024, it supports local 5G and private 5G. Public 5G is expected to be supported in the fall of 2024 onward (at the time of product announcement).

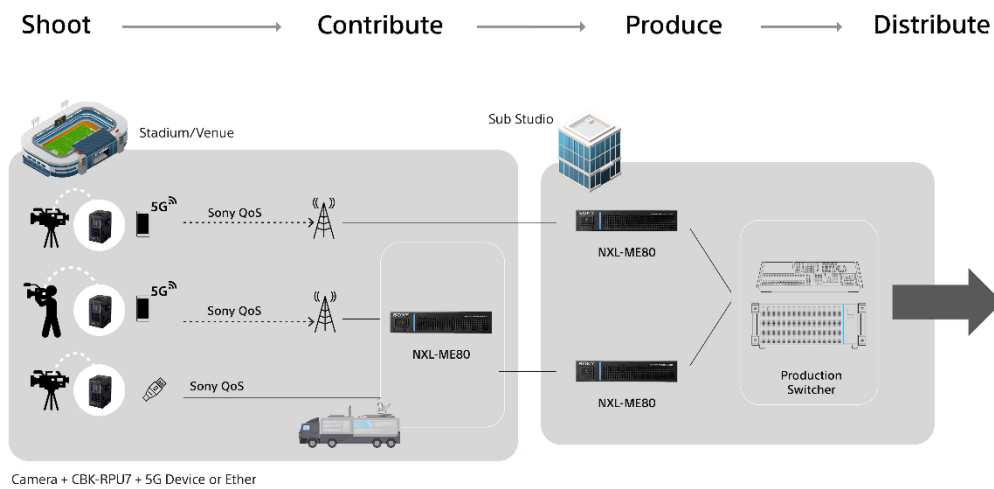

Fig. 8-9 Sony's Video Transmission Solution

### 8.3.5 Public infrastructure

- **Patrol inspection and remote work support by drones and robots [20][21]**

In public infrastructure such as railways, airports, roads, electric power, gas, etc., it is used for patrol inspections by drones and robots, and remote work support by XR devices. As an individual use case, for example, in railroad radio, priority is given to transmitting data with high urgency for maintenance using sub6 while the train is running, and in areas such as stations where vehicles are densely packed, millimeter wave are used for large capacity transmission. It is expected that there will be needs for utilization such as updating internal image data when trains stop at stations and updating service information for passengers (news, weather forecasts, advertisements, etc.).



### 8.3.6 Agriculture

- **Approach to smart agriculture [22]**

The shortage of human resources and the difficulty of successors due to the progress of aging and population decline are major issues facing Japanese agriculture. To address this issue, efforts are being made to implement smart agriculture using digital technology. For example, using sub6 and millimeter wave, remote control of agricultural machinery by level 3 automated driving that is "monitored by humans from a remote location" and remote sensing using drones to grasp the presence of pests and the appropriate harvest period without going to the site. Proof-of-concept experiments are underway to prove that this is possible.



Fig 8-8 Drone flying over tea plantation

### 8.3.7 Exhibitions and Other Events

- **Live Streaming at Event Venues[23]**

In Chapter 5, we demonstrated the performance evaluation of 5G millimeter wave at an event venue. However, in a different event venue, we conducted live streaming during a lecture using multiple public 5G millimeter wave base stations from various mobile network operators and commercial millimeter wave devices, including the millimeter wave-compatible portable data transmitter 'PDT-FP1' (manufactured by Sony) and millimeter wave-compatible smartphones. Although public networks tend to be congested at event venues with many people, the larger communication capacity provided by 5G millimeter wave enabled stable live streaming with high resolution, allowing us to see the mounting status of small components as small as 1-2 mm.

Other equipment used (all manufactured by Sony) included the  $\alpha$  7SIII (camera) and SEL50M28 (macro lens).

stage



LED monitor

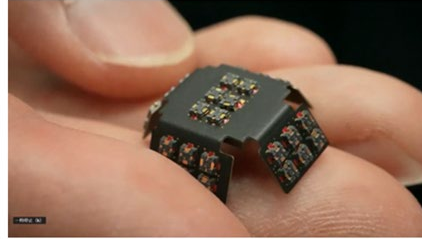

UE side configuration



Portable Data Transmitter, PDT-FP1

Camera, a7S III

macro lens, SEL50M28

Fig. 8-11: Setup and Images of Live Streaming

## References

- [1] Verizon returns to Super Bowl to spotlight new 5G Internet expansion  
<https://www.verizon.com/about/news/verizon-super-bowl-new-5g-internet-expansion>
- [2] At Super Bowl LV, 5G Will Change the Game  
<https://www.pcmag.com/news/at-the-super-bowl-5g-gives-you-7-ways-to-view-the-action>
- [3] "au 5G" conversion of Toyota Stadium from Nagoya Grampus home opening game  
<https://news.kddi.com/kddi/corporate/newsrelease/2020/02/20/4281.html>
- [4] How 5G is transforming live theatre  
<https://www.gsma.com/5GHub/images/5G-Case-Study-Smart-Theatre-digital.pdf>
- [5] ZEPPELIN formed a business alliance with Dentsu Digital and KDDI. Started providing AR platform "ARaddin"  
<https://prtimes.jp/main/html/rd/p/000000010.000036631.html>
- [6] New information dissemination medium "Metaverse homepage" unveiled for the first time! | SoftBank  
<https://www.softbank.jp/mobile/info/personal/news/service/20230428a/>
- [7] The communication speed at Hanshin Koshien Stadium has improved by 1.6 times.  
[https://newsroom.kddi.com/news/detail/kddi\\_nr-207\\_3467.html](https://newsroom.kddi.com/news/detail/kddi_nr-207_3467.html)
- [8] Verizon expands 5G Home Internet and mobility to more customers | About Verizon  
<https://www.verizon.com/about/news/verizon-expands-5g-home-internet>
- [9] UScellular Fixed Wireless Access  
<https://newsroom.uscellular.com/download/1133910/uscellular5gfixedwirelessaccess.pdf>
- [10] Solutions for the manufacturing industry | docomo 5G | docomo business | NTT Communications corporate customers  
<https://www.ntt.com/business/lp/5g/solution/production.html>  
<https://newsroom.detail.html/Pages/news/us/en/2020/nov/1120-factory0>
- [11] Singtel partners Micron to deploy commercial 5G millimetre wave solution at its largest facility – a first in Singapore and for the semiconductor manufacturing sector  
<https://www.singtel.com/about-us/media-centre/news-releases/singtel-partners-micron-to-deploy-commercial-5g-millimetre-wave>
- [12] JFE Steel and KDDI to bring 5G to steel mills from April  
<https://news.kddi.com/kddi/corporate/newsrelease/2020/03/17/4319.html>

- [13] Denso and KDDI Begin Joint Verification of Utilizing 5G for Autonomous Driving to Realize a Safe and Secure Mobility Society  
<https://news.kddi.com/kddi/corporate/newsrelease/2021/03/03/4990.html>
- [14] Private 5G Network from AT&T Now Connecting Researchers and Patients at Lawrence J. Ellison Institute for Transformative Medicine of USC  
[https://about.att.com/story/2021/5g\\_ellison\\_institute.html](https://about.att.com/story/2021/5g_ellison_institute.html)
- [15] Solutions for Healthcare | docomo 5G | DOCOMO Business | NTT Communications Corporate Customers  
<https://www.ntt.com/business/lp/5g/solution/medical.html>
- [16] Robotics Solutions | docomo 5G | DOCOMO Business | NTT Communications Corporate Customers  
<https://www.ntt.com/business/lp/5g/solution/robot.html>
- [17] LU800 – LiveU  
<https://www.liveu.tv/ja/products/create/lu800>
- [18] Remote Production Unit CBK-RPU7 (Sony)  
<https://www.sony.jp/nxl/products/CBK-RPU7/>
- [19] Media Edge Processor NXL-ME80 (Sony)  
<https://www.sony.jp/nxl/products/NXL-ME80/>
- [20] 5G Business Design WG Document 2-5 (Slide 12)  
[https://www.soumu.go.jp/main\\_content/000860115.pdf](https://www.soumu.go.jp/main_content/000860115.pdf)
- [21] Accelerating DX in Local 5G Industries and Local Governments to Realize a Prosperous Society  
<https://jpn.nec.com/nsp/5g/local5g/index.html>
- [22] Initiatives for "Smart Agriculture" in Kagoshima  
<https://www.fujitsu.com/jp/innovation/5g/usecase/casestudies/horiguchi/>
- [23] Summary Report of WTP2024's 5G/Local 5G mmWave Dissemination Event  
<https://xgmf.jp/2024/06/03/14/>

## **9 Existing solutions for millimeter wave dissemination**

In order to disseminate millimeter wave, it is important to be able to procure enough devices and measuring instruments for developing and manufacturing the equipment that constitutes the network. This chapter introduces solutions for terminals, base stations, antennas, measuring instruments, etc. based on actual product examples.

### **9.1 Terminal**

As of December 2022, more than 170 products from more than 65 manufacturers have been released that support millimeter wave. As types of terminals, smartphones, PCs, IoT devices such as IP cameras, mobile wireless LAN routers, modules, CPE (Customer Premises Equipment), FWA, etc. are already available. At present, most smartphones that support millimeter wave are high-end models, but the number of types of terminals that support millimeter wave is gradually increasing, and it is expected that it will spread to mid-range models in the future. It is important to use millimeter wave not only for general users but also for professional use cases. Therefore, some smartphones are equipped with an HDMI terminal as an interface for professionals and support high-definition video transmission.

Since millimeter wave has very strong directivity, the strength of the radio waves can vary greatly depending on the direction in which the terminal aims. For terminal reception, devices that dynamically respond to changing reception environments by grasping and recording the radio wave environment over 360 degrees so that millimeter wave signals can be received from any direction., There is a beam management system using AI. There are also devices that perform management, making it possible to respond to changing environments and obstacles. There are also smartphones equipped with an application that assists in determining which direction the terminal is facing to receive millimeter wave more easily.



Fig. 9-1 Millimeter Wave CPE (by Nokia)



Fig. 9-2 Smartphones that support high-quality video transmission that supports millimeter wave (by Sony)



Fig. 9-3: Scene of Data Transmission from Mirrorless Camera  $\alpha^{\text{TM}}$  The 5G-compatible portable data transmitter 'PDT-FP1' (manufactured by Sony) enables high-speed, low-latency video transmission.



Fig. 9-4: Millimeter Wave-Compatible Wi-Fi 6E Mobile Router 'MR6550-100APS' (Manufactured by NETGEAR) Supporting Carrier 5G/Local 5G

## 9.2 Base station

Due to its radio wave propagation characteristics, millimeter wave requires high effective isotropic radiated power (EIRP) in order to increase the propagation distance. Base stations with 60 dBm or more are already in the market, and downlink speeds of 10 Gbps have been achieved in commercial networks even when they are 10 km away from CPE terminals. Along with the increase in EIRP of base stations, reductions in size, weight and power consumption are also progressing at the same time. Wider bandwidths are also being developed to accommodate wider frequency allocations, and it is already possible to procure base stations with a continuous 800MHz bandwidth and non-continuous 1.4GHz bandwidth (compatible with frequency separation class III) in the market. In addition, many base stations need to be deployed in order to secure a certain coverage.

As a result, miniaturized base stations can be flexibly installed wherever they are needed, and will play an important role in millimeter wave deployment. There are also small base stations that are specialized for easy installation on streetlights. In addition, millimeter wave has a large shielding loss, and it is generally difficult to support indoor coverage from base stations installed outdoors, so base stations specialized for indoor use are also being prepared.

Modem processors for base stations are emerging that have achieved miniaturization, low cost, and low power consumption through SoC and modularization by diverting the design assets of modem RF for mobile stations.

The millimeter wave RU (Radio Unit) that supports ORAN is compact, lightweight, and consumes low power. The built-in antenna device supports beamforming. Some products have a dual-band configuration of Sub 6 and millimeter wave. In addition, by integrating the radio unit (RU) and the control unit (CU/DU), a compact product has been realized, enabling rapid network construction.



Fig. 9-3 Appearance of millimeter wave RU (by NEC, Fujitsu)



### 9.3 Antenna device

The millimeter wave band allocated in Japan is the 28 GHz band, but there are regions where 26 GHz, 39 GHz, and 41 GHz are available worldwide. There are products that can handle these frequency bands with a single antenna module, and common devices equipped with such modules can be used worldwide. There is also a commercialized antenna module that enables radio wave radiation in two directions with one RFIC by forming an L-shaped multilayer resin board and placing antennas on each of the two boards facing in different directions. It is expected to realize stable millimeter wave wireless communication, reduce the number of communication devices, and contribute to thinner terminals and lower manufacturing costs.

As devices for base stations, millimeter-wave phased array radios that can control the directivity of radio waves with high accuracy by using a real-time phase shift mechanism with little phase variation of high-frequency signals and phase, amplitude variations, and compensation mechanisms have been developed, and low-cost, mass-produced silicon CMOS integrated circuit chips have also been realized.

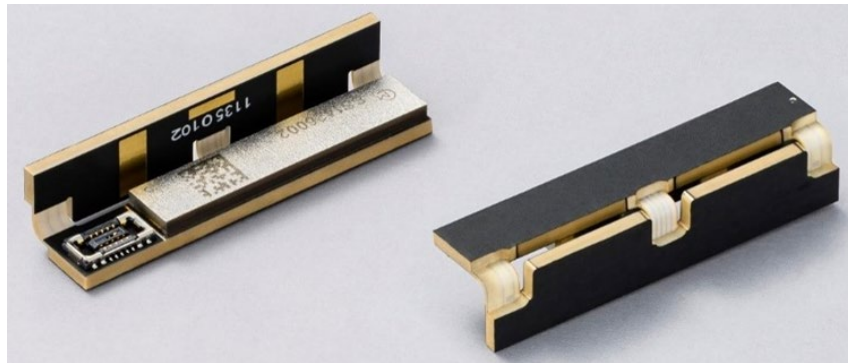

Fig. 9-4 L-shape Antenna Array Integrated Module (by Murata)

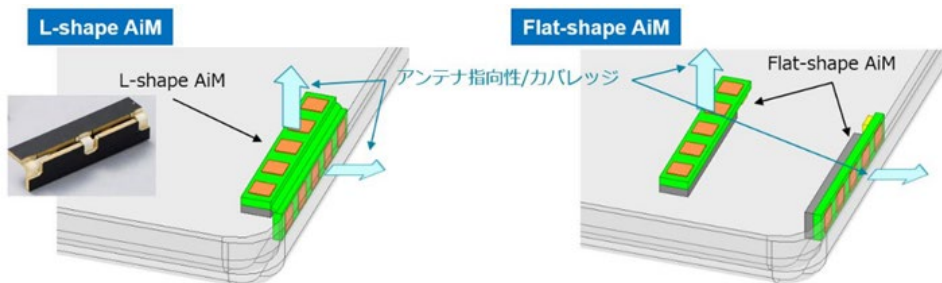

Fig. 9-5 In-terminal array of Antenna Array Integrated Module (by Murata)



Fig. 9-6 Global Millimeter Wave band antenna modules (24 – 29 GHz & 39 – 41 GHz)  
(by Qualcomm)

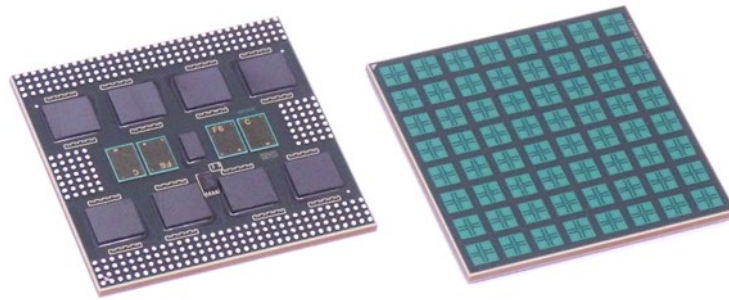

Fig. 9-7 8x8 Array Antenna Module for Base Stations (24 – 29 GHz)  
(by Fujikura)

## **9.4 Measurement evaluation equipment**

Measurement and evaluation equipment and simulators are necessary when developing RFICs, during evaluating equipment that incorporates RFICs, and when confirming and verifying the actual performance of operating systems.

FR2 evaluation requires equipment with millimeter wave transmission / reception functions that can support the physical layer between the terminal and the RU (gNB). Various manufacturers have already prepared their equipment for each measurement field.

### **9.4.1 FR2 terminal performance test**

RF testing of terminals in FR2 uses over-the-air (OTA) testing because it is challenging to connect cables and connectors.

Specification TS38.521-2 identifies OTA testing for 3GPP. For this measurement, you need to use a gNB emulator that generates simulated radio signals from the base station toward the terminal, a channel model emulator that simulates transmission space characteristics, and a frequency converter from several GHz to FR2. A radio head and an anechoic box are required. In addition, the measurement evaluation in Chapter 5 describes the evaluation of terminal characteristics using this equipment.

### **9.4.2 FR2 area test**

Unlike RFIC and equipment development, mobile network operators and system integrators need to verify whether terminals operate as expected and are stress-free under actual usage conditions. Equipment that can analyze logs of communication exchanges with base stations during actual operation is necessary. Each company usually releases products with unique characteristics. There is a tool with dedicated software on mobile phones that records and analyzes logs in operating conditions. If the terminal used for evaluation supports FR2, it is possible to simultaneously record and analyze communication logs among anchor LTE, FR1 and FR2 terminals, and base stations, depending on the connection status.

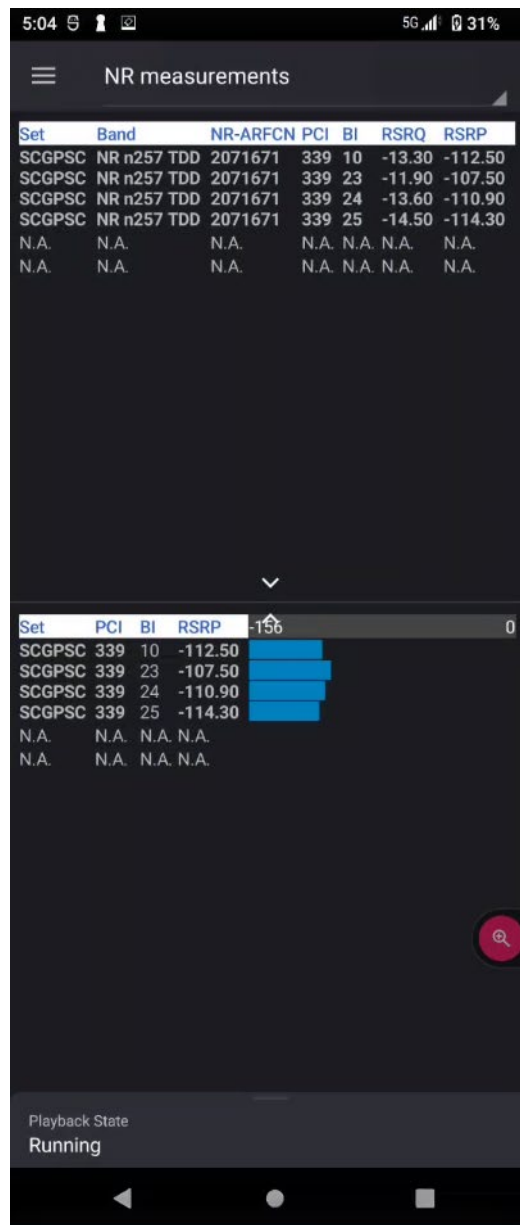

Fig. 9-8 FR2 monitor example on smart phone by Keysight Nemo Handy

### 9.4.3 Radio wave environment monitor

To ensure reliability for system integrators and service providers who deploy base stations for their local 5G service providers, it is important to conduct radio wave environment surveys before the deployment and during operation. However, with 5G deployment and operation, the analysis of interference signals becomes more complex. This is because signals tend to appear in bursts and pulses based on traffic conditions. As the sweep speed is slow and the dead time is difficult to predict, traditional spectrum analyzers may not be able to capture everything. The detection may also become difficult because the carrier signal masks the interfering signal.

A signal analyzer with a real-time spectrum analyzer (RTSA) is effective in solving these challenges. Real-time spectrum analyzers use snapshot Fast Fourier Transform (FFT) techniques to simultaneously sample, compute, and process data.

Among battery-powered portable products suitable for on-site troubleshooting, products with a real-time bandwidth of 100 MHz or higher are already on the market. 3GPP-compliant RF analysis tools are used for base station installation, operation and maintenance, and inspection. A UE simulator that supports millimeter wave is also available with enabling base station and network testing.



Fig. 9-9 Network Installation and Maintenance Test Tools and Network Performance Capacity Testers (by VIAVI)

## 9.5 Repeater

As mentioned in Chapters 4 and 5, one way to expand millimeter wave coverage is to install many small cells and repeaters. Small cells are more economical and can increase capacity than building new towers, but they require backhaul installations, such as fiber, which is a complex and expensive task. On the other hand, millimeter wave repeaters are radio wave relay devices, which are simpler to install than small cells, and have the effect of improving electric field strength and throughput by relaying radio waves to areas where radio waves cannot reach due to shielding materials. The relay method is a non-regenerative system, and it is amplified and relayed from the base station side (donor) to the terminal side (service) at 28 GHz without frequency conversion, and can operate with extremely low latency.

In addition, there are products that have a built-in bidirectional amplifier that automatically switches transmission and reception by receiving SSB signals periodically transmitted from the base station without using GPS. There are also smart repeaters that are equipped with AI functions and are easy to install and cost-effective, and are installed in LED street lights in the United States.



### Integrated antenna:

- Configuration with terminal counter antenna on the front side and base station counter antenna on the back side (18×18×5cm)
- The base station counter antenna is a 32-element array antenna that automatically searches for base stations by beamforming

The terminal-to-terminal antenna is configured to be a four-element patch antenna that can radiate at a wide angle

- The main specifications are as follows.
  - Signal bandwidth: 400MHz
  - Base station counter (uplink) output EIRP): 42dBm/400MHz
  - Terminal-to-end (downlink) output (EIRP): 30dBm/400MHz

Fig. 9-10 Millimeter Wave Repeater (by DX Antenna)

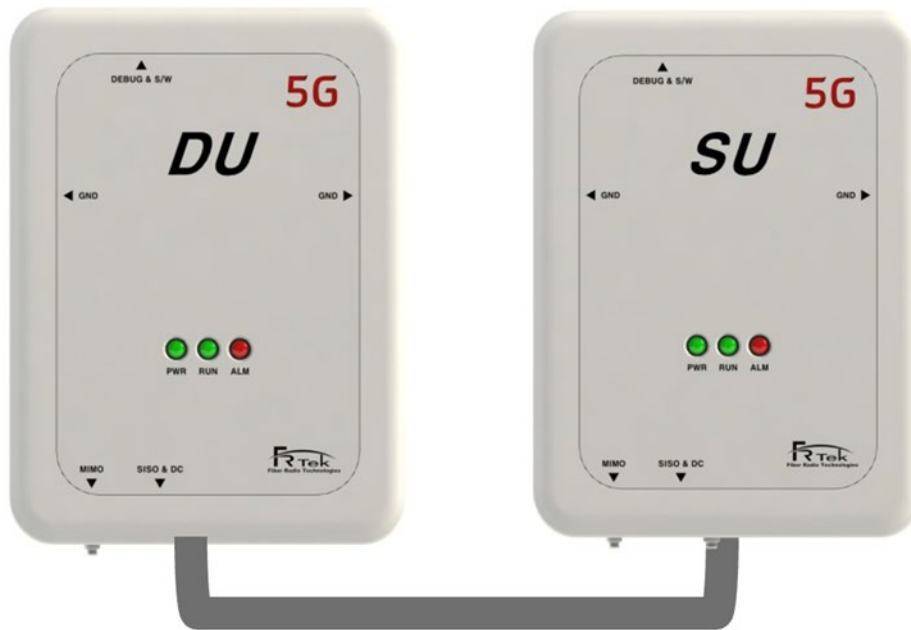

Fig. 9-11 Millimeter wave repeater consisting of two enclosures, a donor unit and a service unit (by FR-Tech)

## **10 Millimeter wave business outlook**

As shown in Chapter 9, solutions such as millimeter wave network equipment, terminals, and measuring devices are in place, and the development of 5G utilizing these is desired, but the deployment of millimeter wave networks, the spread of terminals, and the development of services that make full use of their capabilities and characteristics have been slow. From a situation where a negative chain reaction is occurring, how to convert these into a positive reaction will be the key to future business outlook. This chapter summarizes possible efforts to transform into a positive chain reaction.

### **10.1 Area development**

From the viewpoint of millimeter wave utilization, equipment sophistication is important, and in order to solve the problems arising from propagation characteristics, it is required that the introduction of RU (Radio Unit) that can improve the sophistication of beamforming, high efficiency, and low power consumption, and use a NR-DC (Dual Connectivity) which combines Sub6 and millimeter wave. Currently, the main focus is on the introduction of Sub6, but the introduction of millimeter wave by NR-DC is effective in introducing millimeter wave smoothly.

In order to smoothly promote millimeter wave infrastructure development, it is necessary to promote infrastructure sharing and efficient investment utilizing existing assets, and to support investment in disadvantaged areas through subsidies and other means.

In order to promote the use of millimeter wave, it is necessary to promptly develop systems to enable the use of repeaters and high-power terminals, and to consider speeding up and simplifying licensing procedures, such as making base station licenses eligible for comprehensive licenses. In response to this, the Ministry of Internal Affairs and Communications has already released a report on the technical conditions of repeaters and high-power terminals in June 2023[1], and it is expected that related regulations will be developed as soon as possible.

In local 5G, since there is a high demand for the introduction of millimeter wave standalone operation, implementation of standalone operation in millimeter wave is effective. It is necessary to realize and introduce it to the market. Enhancement of the equipment lineup is also expected.



## 10.2 Promoting and supporting 5G/millimeter wave to other industries

Although there are many potential needs for 5G/millimeter wave in industries other than the mobile communications industry, many companies and organizations are not aware of its effectiveness, and even if they are, they are hesitant about how to utilize and introduce it.

In addition, since many functions and parameters are stipulated as standard specifications in order to make 5G systems universally available for various applications, special knowledge and skills are required to optimize and operate the system at the time of introduction and after introduction. It is difficult for companies and organizations in other industries to implement by themselves.

Activities to appeal the effectiveness and use cases of 5G/millimeter wave to people in such other industries, and support for system introduction will be the first key to dissemination. Mobile network operators and local 5G operators are already responding individually, but in order to promote the spread of 5G/millimeter wave in Japan and overseas, it is necessary for mobile communications related ministries, companies, and organizations to cooperate in this activity as a cooperative area.

As part of our promotional activities, we launched a media outlet through 5GMF's ad hoc initiative and began operations under the name 'Telegraphic'.

<https://www.telegraphic.jp/en/>

Next, we will quote the web page of 'Telegraphic' and introduce its activity policy and overview.

---

### What is TeleGraphic?

In preparation for the commercialization of 5G, the 28 GHz millimeter wave band has been allocated in a wide bandwidth of 400 MHz per operator, along with the 3.7 GHz and 4.5 GHz sub6 frequency bands, and the 4.7 GHz band has been allocated for local 5G for spot use in limited areas by local companies and local governments. Millimeter wave has a wide bandwidth of 400 MHz per operator. Millimeter wave, with its wide frequency bandwidth, is expected to contribute to the creation of new services in various industrial fields as a state-of-the-art communication technology that is positioned as the "core" of 5G, including ultra-high-speed, large-capacity, and low-latency communications, one of its features. In addition, since millimeter wave can be positioned as a prelude to terahertz waves (6G), which will come next, the introduction of millimeter wave at this time may directly lead to continued social development, industrial promotion, and a sustainable society in the near future.

Millimeter wave is a leading-edge telecommunications technology that represents the telecommunications industry. Needless to say, there are many other industries that have cutting-edge technologies and facilities that are on the verge of social implementation or have already been implemented (Japan, in particular, boasts the quality and quantity of cutting-edge technologies in the manufacturing industry that have attracted much attention from overseas). We believe that collaboration between the most advanced technology in telecommunications (millimeter wave) and the most advanced technology in each industry will lead to the creation of new businesses, and that millimeter wave can update the most advanced technology in other industries with higher added value. However, we believe that it is necessary for engineers/business producers in the telecommunications industry to learn the details of cutting-edge technologies and business models in other industries, and it is also necessary for the industrial technology side to correctly understand the characteristics of telecommunications technologies represented by millimeter wave.

'Telegraphic' will start as a platform to link the collaboration of cutting-edge communication technology represented by millimeter wave and cutting-edge industrial technology to new business creation. It is also a media for organic collaboration between engineers/business producers on both sides of telecommunication and industrial technologies. For this reason, articles and events on "TeleGraphic" will basically be organized around the three axes of 1) the cutting edge of telecommunications technology, 2) the cutting edge of industrial technology, and 3) business development. At the same time, "TeleGraphic" is an English version also now open to the public. We believe that we can make a small contribution as a platform for technology marketing of Japanese telecommunication/industrial technologies to overseas markets.

---

---

At 'TeleGraphic', we invite key people from various industries once a month to provide topics on the latest technologies in their respective fields. Along with the speakers who provide these topics, we also hold workshops to discuss the promotion and commercialization of 5G/millimeter wave. We encourage those interested in this white paper and those from various industries interested in utilizing 5G/millimeter wave to register with this media and participate in our events/workshops.

Registration URL: <https://www.telegraphic.jp/weekly/>

As part of further approaches to other industries, we can accelerate the social implementation and commercialization of 5G/local 5G and millimeter wave by promoting collaboration and cooperation between industry groups, in addition to individual business approaches. It is important not only to involve other industry groups in XGMF activities but also for XGMF itself to participate in meetings and events of other industry groups, explaining and demonstrating the use cases and benefits of 5G/local 5G and millimeter wave in other industries. To promote collaboration with the manufacturing industry, which is one of the most important industries for the application of 5G/local 5G and millimeter wave, XGMF has signed an MoU with the Flexible Factory Partnership Project (FFPA)[2]. Additionally, XGMF has continued its cooperation with the 5G Alliance for Connected Industries and Automation (5G-ACIA), with which it had already signed an MoU under 5GMF. In the XGMF ODAIBA IX Core project, we are promoting the dissemination of 5G/local 5G and millimeter wave by sharing information and holding workshops in collaboration with FFPA and 5G-ACIA.

### **10.3 Providing a place to promote the spread of millimeter wave**

In view of the various factors discussed in this white paper, it is considered that elements of R&D and service development remain in millimeter wave deployment. First of all, it is important to prepare a place where the benefits of millimeter wave can be tested and demonstrated. It is important to provide such place to promote open innovation. It is desirable that companies, organizations, and academia in all industries can freely participate in these forums without charge and operate them as cooperative areas. In addition, it is necessary to simplify and speed up licensing procedures.

#### **10.3.1 For consumer users**

Millimeter wave base stations can be concentrated and deployed in typical places where millimeter wave is required for consumer users (hot spots, stadiums, event venues, etc.), and high throughput can be maintained even in congested environments. Appeal the effectiveness and have them experience it. By installing it in a place with high off-road demand, it is possible to recognize the difference between millimeter wave equipped terminals and non-millimeter wave terminals. In order to extend millimeter wave coverage at low cost, repeaters can also be utilized. Being able to experience using smartphones and other devices sold in the market is an important factor. Using such a place, we will hold events with millimeter wave + use cases and promote that it can be enjoyed on millimeter wave equipped terminals.

### **10.3.2 Millimeter wave lab for consumer services developers**

We will prepare an experimental environment to lead to the development and deployment of high-quality services that can make use of millimeter wave such as XR on the premise of using commercial networks of operators. It is not necessary to deploy in high-demand areas, and it is desirable that the conditions of traffic can be managed to some extent. It differs from the millimeter wave area for general users in that it provides an experimental environment such as for data acquisition.

### **10.3.3 Local 5G developer millimeter wave labs**

The affinity with local 5G is described in Chapter 7. We prepare a place where you can actually experience use cases that can take advantage of the performance of millimeter wave. In this verification facility, local 5G system providers, OT (Operation Technology) players and private network users will promote the effectiveness of millimeter wave. It is also necessary to clarify the difference in characteristics from Wi-Fi.

## **10.4 5G wireless human resource development**

In order to promote the spread of 5G/millimeter wave, it is important to appeal the effectiveness and support to other industries, but the current issue is the lack of human resources who can promote it. In order to overcome this issue, it is extremely important to develop human resources for 5G wireless networks. In addition to human resource development on the 5G/millimeter wave provider, consideration should also be given to human resource development on the user side. In addition, efforts are required to develop and secure human resources who can connect and combine users, companies, universities, etc.

### **References**

- [1] "Technical Conditions for Relay Stations and High-Output Terminals for Expanding the Use of 5G" among the "Technical Conditions for New Generation Mobile Communication Systems" - Partial Report from the Information and Communications Council -  
[https://www.soumu.go.jp/menu\\_news/s-news/01kiban14\\_02000597.html](https://www.soumu.go.jp/menu_news/s-news/01kiban14_02000597.html)
- [2] XGMF News: XG Mobile Promotion Forum and FFPA Sign Memorandum of Understanding on Industrial Wireless Communication.  
<https://xgmf.jp/2024/10/09/861/>

## Conclusion

It is clear that the needs for 5G will become more diverse. The demand for higher performance will increase in order to achieve continuous social development and a sustainable society in the future. In order to realize this, the dissemination of millimeter wave, which is a newly introduced frequency band from 5G, is the key and urgent issue to bring a clear performance difference from 4G. This white paper, which was developed by millimeter wave promotion ad-hoc established within the 5G Mobile Promotion Forum (5GMF), comprehensively incorporates the considerations and information necessary for the dissemination of millimeter wave. After grasping the current situation and issues such as why millimeter wave is necessary in the first place and why millimeter wave is not widespread, we included information on technologies, use cases, deployment scenarios, and available solutions that can address the issues. We also focused on the affinity between local 5G and millimeter wave, which is expected to be used in factories and facilities in Japan, and mentioned the synergistic effect of promoting their dissemination. We also included recommendations on how to work from a business and institutional perspective in order to promote the spread of millimeter wave.

On April 1, 2024, the 5GMF and the Beyond 5G Promotion Consortium were integrated, leading to the establishment of the XG Mobile Promotion Forum (XGMF). Consequently, the activities of the former 5GMF Millimeter Wave Promotion Ad Hoc were transferred to the ODAIBA IX Core project within XGMF.

Based on this white paper, we, as ODAIBA IX Core project will vigorously promote our assessments aiming to the dissemination of millimeter wave and Local 5G. We hope that this white paper will be useful not only for companies and/or organizations involved in 5G and local 5G, but also for people in all industries who are considering improving the efficiency of their operations and expanding their business through the introduction of 5G. This white paper also includes information on technologies and solutions that will benefit the dissemination of millimeter wave. Technological enhancement is necessary to improve the performance of equipment and develop new use cases. Millimeter wave is also an important frequency resource for 6G, and the lessons and learns obtained from millimeter wave solutions, implementation and operation will be an important baseline for frequency development that extends to sub-terahertz. For that reason, we would like those people who are involved in research and development of future communication technology in companies and academia to pay attention.

We plan to continue our studies and update the content of the white paper in ODAIBA IX Core project. We would appreciate receiving opinions, impressions, requests, and

provision of information from those who read this white paper. Additionally, we would appreciate it if you could register with the media 'TeleGraphic' introduced in this white paper and participate in the regularly planned events/workshops. By doing so, you can help promote the dissemination of 5G/local 5G and millimeter wave, and expand cross-industry networking and collaboration with industry stakeholders.

## Appendix (Existing solutions for the spread of millimeter wave List of reference information links)

### Terminal solution example

<https://www.qualcomm.com/products/technology/modems/snapdragon-x65-5g-modem-rf-system>  
<https://www.qualcomm.com/products/technology/modems/snapdragon-x70-modem-rf-system>  
<https://www.qualcomm.com/products/technology/modems/snapdragon-x75-5g-modem-rf-system>  
<https://www.qualcomm.com/products/mobile/snapdragon/smartphones/snapdragon-8-series-mobile-platforms/snapdragon-855-mobile-platform>  
<https://www.qualcomm.com/products/mobile/snapdragon/smartphones/snapdragon-8-series-mobile-platforms/snapdragon-870-5g-mobile-platform>  
<https://www.qualcomm.com/products/mobile/snapdragon/pcs-and-tablets/snapdragon-8-series-mobile-compute-platforms/snapdragon-8cx-gen-2-5g-compute-platform>  
<https://www.qualcomm.com/products/mobile/snapdragon/pcs-and-tablets/snapdragon-8-series-mobile-compute-platforms/snapdragon-8cx-gen-3-compute-platform>  
<https://www.qualcomm.com/products/technology/modems/snapdragon-x62-5g-modem-rf-system>  
<https://www.nokia.com/networks/technologies/mmwave-fwa/>  
<https://xperia.sony.jp/xperia/xperiapro/>

### Examples of base station solutions

<https://www.fujitsu.com/global/products/network/solutions/5gran/>  
[https://jpn.nec.com/nsp/5g\\_vision/o-ran.html](https://jpn.nec.com/nsp/5g_vision/o-ran.html)  
<https://jpn.nec.com/nsp/5g/local5g/product.html>  
<https://www.nokia.com/networks/mobile-networks/airscale-radio-access/mmwave-radio/>  
<https://www.nokia.com/blog/nokia-fixes-mmwave-wireless-access/>  
<https://www.nokia.com/about-us/news/releases/2021/06/08/nokia-qualcomm-and-usc cellular-hit-extended-range-5g-world-record-over-mmwave/>  
<https://www.nokia.com/about-us/news/releases/2021/10/12/nokia-gives-fixed-wireless-access-a-boost-by-enabling-5g-mmwave-indoor-installations/>

<https://www.nokia.com/about-us/news/releases/2022/06/21/nokia-and-elisa-achieve-over-2-gbps-5g-uplink-speeds-on-mmwave-with-qualcomm-solutions/>

<https://www.nokia.com/about-us/news/releases/2022/10/18/nokia-5g-mmwave-fwa-technology-selected-for-nbn-fixed-wireless-broadband/>

<https://www.nokia.com/about-us/news/releases/2022/10/12/nokia-demonstrates-immersive-stadium-experience-with-5g-private-wireless-at-2022-tissot-uci-track-world-championships/>

<https://www.nokia.com/about-us/news/releases/2022/11/15/nokia-and-tpg-telecom-set-new-5g-uplink-speed-record-in-australia/>

<https://www.ericsson.com/en/small-cells/outdoor-coverage>

<https://www.ericsson.com/en/portfolio/networks/ericsson-radio-system/radio/small-cells/indoor/indoor-air-1279>

#### Antenna device solution example

[https://jpn.nec.com/press/201906/20190603\\_01.html](https://jpn.nec.com/press/201906/20190603_01.html)

<https://www.qualcomm.com/products/technology/modems/rf/qtm545>

<https://mmwavetech.fujikura.jp/ja/5g/>

#### Measuring instrument solution example

<https://www.viavisolutions.com/ja-jp/products/oneadvisor-800-wireless-platform>

<https://www.viavisolutions.com/ja-jp/node/60033>

<https://www.viavisolutions.com/ja-jp/products/tmlite-network-tester#overview>

<https://www.keysight.com/jp/ja/product/S8711A/s8711a-uxm-5g-test-application.html>

<https://www.keysight.com/jp/ja/product/NTH00000B/nemo-handy-handheld-measurement-solution.html>

<https://www.keysight.com/jp/ja/cmp/use-case/5g-field-interference-hunting.html>

#### Repeater solution example

<https://movandi.com/study-reveals-huge-cost-savings-for-mmwave-5g-deployments-using-streetlights/>